

KATALOGU I PRODUKTEVE





Zgjedhja juaj më e sigurtë

prej 2015



RRETH NESH

AlbBakër u themelua në vitin 2015 dhe nisi si një biznes i vogël me një fokus të veçantë në sigurimin e lëndëve të para për procesin e avolzhimit të elektromotorrave. Sot ne jemi lider në kete fushë jo vetëm në Shqipëri por edhe në rajon. Në këtë pjesë te industrisë ne bashkëpunojmë me kompani me famë botërore si: SARKUYSAN, FAET, DUCATI ENERGI, etj.

Në 2017-tën ne filluam zgjerimin drejt një fushe tjetër siç është ajo e automatikës, kryesisht ne materialet elektrike industriale por jo vetem.

Në 2020-ën pas studimeve të vazhdueshme të nevojave të tregut, ne nisëm disa marveshje bashkepunimi me kompani shumë kompetitive në tregun botëror siç janë Schneider, Emas , Emko ,Entes etj. Perzgjedhja e tyre u be per arsye të kualitetit të lartë dhe çmimit konkurues që këta prodhues kanë.

Pas vitit 2021 ne jemi fokusuar tek furnitoret ne Azi.

Zhvillimet teknologjike ne Kine, Taiwan, Indi, Japoni dhe Kore, kanë berë që besushmëria e shumë prodhuesve të këtyre vendeve të rritet shumë në Europë .

Shumë vende të bashkimit europian kanë parë në këto tregje një larmishmëri produktesh me një cilësi-cmim për tu admiruar.

Për këto arsye ne kemi filluar ne 2021-shin të blejmë disa produkte Aziatike në vendet BE për tu garantuar që standarti i tyre është i lartë dhe çertifikimet janë reale. Rezultatet kanë qenë mbreslënëse si nga ana e kualitetit ku është edhe fokusi jonë kryesor, por dhe nga çmimi shumë konkurues.

Në vitin 2023 kemi filluar bashkëpunimin direkt me disa prodhues në Kinë si Uni-Trend, lider botëror në fushen e instrumentave digjitale ku tashmë ne jemi dhe distributori i tyre ekskluziv në Shqipëri.

Poashtu filluam bashkëpunimet me Invt, një nga prodhuesit më inovativë në rajonin e Shenzhenit ne Kine, Daier për micro celsat, CNC electric etj.

Në vitin 2024, ne vazhdojmë rrugëtimin tonë drejt inovacionit dhe vazhdojmë sjellim tek ju më të rejat e fushës elektrike/industriale.

Ky katalog është një shprehje e aventurës sonë, një rrugëtim i ndërtuar me përvojë, përkushtim dhe sukses të përbashkët. Faleminderit që jeni pjesë e udhëtimit tonë dhe vazhdojmë së bashku drejt të ardhmes elektrike.

www.albbaker.com
info@albbaker.com
+355 69 292 9800



Çelësa Tumbler

Faqe 8-9



Çelësa bazikë

Faqe 10-12



Çelësa start/stop për automjete

Faqe 14



Pulsaneria Gwest

Faqe 16-19



Pulsaneria Emas

Faqe 20-26



Pulsaneria CNC

Faqe 27-28



Sinjalizues të ndryshëm

Faqe 30-32



Çelësa parket

Faqe 34-40



Çelësa fundorë

Faqe 42-54



Sensorë Emas

Faqe 55-56



Rele analoge

Faqe 58-60



Rele digjitale

Faqe 61-63



Rele të llojeve të ndryshme

Faqe 64-66



Rele & analizatorë paneli Entes

Faqe 68-72



Kontrollues temperature & Sensorë

Faqe 74-80



Mufte & Kabull

Faqe 82-84



Kapikorda

Faqe 86-94



Bashkues kabulli

Faqe 96-106



Aksesorë për vinça

Faqe 108-112



Automatika

Faqe 114-128



Inverter driver

Faqe 130-132



Kondensatorë & Transformatorë

Faqe 134-136



Helika, kushineta & permistopa

Faqe 138-142



Linja Uni-Trend

Faqe 144-161

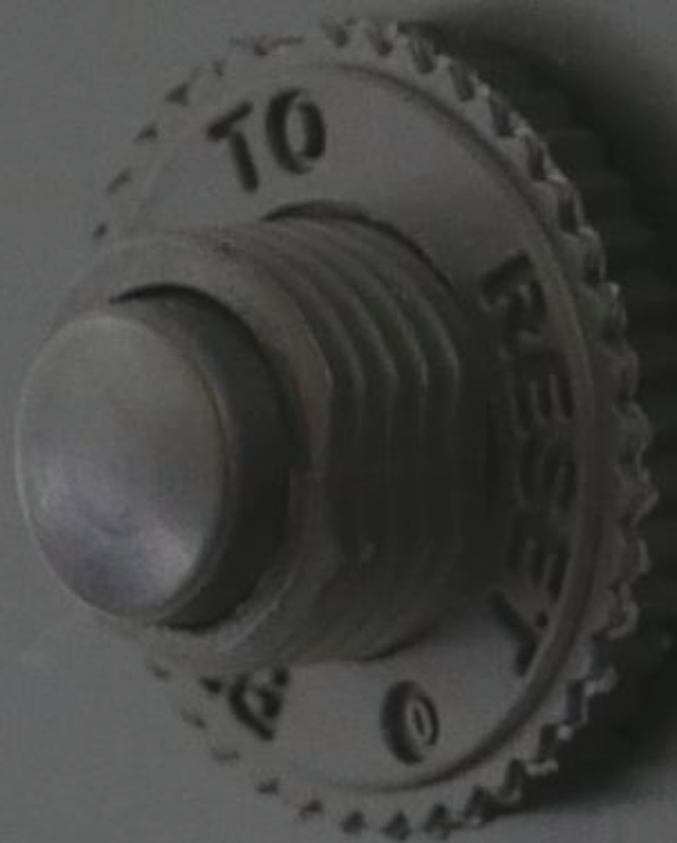

ANCHOR
LIGHT



RUNNING
LIGHT



www.albbaker.com

OR
IT

NG
IT



ÇELËSA BAZIKË DHE TUMBLER

emas

Çelësä Tumbler tek, 16A - 250V/AC



Kodi	Funksioni	Diametër	Kodi	Çmim
MA111	ON-OFF	2P		
MA112	ON-ON	3P	16A-250V AC	
MA113	ON-OFF-ON	3P		

emas

Çelësä Tumbler tek , 16A- 250V/AC me gominë



Kodi	Funksioni	Diametër	Kodi	Çmim
MA121	ON-OFF	2P		
MA122	ON-ON	3P	16A-250V AC	
MA123	ON-OFF-ON	3P		

emas

Çelësä Tumbler dopio , 16A- 250V/AC



Kodi	Funksioni	Diametër	Kodi	Çmim
MA211	ON-OFF	4P		
MA212	ON-ON	6P	16A-250V AC	
MA213	ON-OFF-ON	6P		

aier

Çelësä Tumbler tek , 15A- 250V/AC



Kodi	Funksioni	Diametër	Kodi	Çmim
AL152S/2	ON-OFF	2P		
AL152S	ON-ON	3P	15A-250V AC	
AL153S	ON-OFF-ON	3P		
AL155S	(ON)-OFF-(ON)	3P		

aier

Çelësä Tumbler dopio , 15A-250V/AC



Kodi	Funksioni	Diametër	Kodi	Çmim
AL156S	ON-OFF	4P		
AL157S	ON-ON	6P	15A-250V AC	
AL158S	ON-OFF-ON	6P		
AL160S	(ON)-OFF-(ON)	6P		

Çelësa Tumbler tek , 6A- 250V/AC

Eaier

Kodi	Funksioni	Diametër	Kodi	Çmim
AL152/2	ON-OFF	2P		
AL152	ON-OFF	3P	6A-250VAC	
AL153	ON-OFF-ON	3P		



Çelësa Tumbler tek , 6A- 250V/AC

Eaier

Kodi	Funksioni	Diametër	Kodi	Çmim
AL156	ON-OFF	4P		
AL157	ON-OF	6P	6A-250V AC	
AL158	ON-OFF-ON	6P		



Çelësa Tumbler tek , 15A- 250V/AC me rikthim

Eaier

Kodi	Funksioni	Diametër	Kodi	Çmim
AL153A	ON-(ON)	2P		
AL154	ON-OF-(ON)	3P	15A-250V AC	
AL155	(ON)-OFF-(ON)	3P		



Çelësa Tumbler dopio , 15A- 250V/AC me rikthim

Eaier

Kodi	Funksioni	Diametër	Kodi	Çmim
AL156A	(ON)-OF	4P		
AL158A	ON-(ON)	6P		
AL159	ON-OFF-(ON)	6P	15A-250V AC	
AL160	(ON)-OFF-(ON)	6P		



EMAS

Eaier

Eaier



Kodi CMIMI
AL161A



Kodi CMIMI
AL161B



Kodi CMIMI
AL161B

IP20



Kodi	A71B1K11
Fuqia	6A-(250VAC)
Dalja	3P me dritë
Çmim	

IP20



Kodi	A71B1K11
Fuqia	6A-(250VAC)
Dalja	3P me dritë
Çmim	

IP20



Kodi	A71B1S11
Fuqia	6A-(250VAC)
Dalja	3P me dritë
Çmim	

IP20



Kodi	A71B1Y11
Fuqia	6A-(250VAC)
Dalja	3P me dritë
Çmim	

IP20



Kodi	A21B1H10
Fuqia	16A-(250VAC)
Dalja	2P pa dritë
Çmim	

IP20



Kodi	A21B1K11
Fuqia	16A-(250VAC)
Dalja	3P me dritë
Çmim	

IP20



Kodi	A21B1S11
Fuqia	16A-(250VAC)
Dalja	3P me dritë
Çmim	

IP20



Kodi	A21B1K10
Fuqia	16A-(250VAC)
Dalja	2P pa dritë
Çmim	

IP20



Kodi	A12B1H10
Fuqia	16A-(250VAC)
Dalja	4P pa dritë
Çmim	

IP20



Kodi	A12B1K11
Fuqia	16A-(250VAC)
Dalja	4P me dritë
Çmim	

IP20



Kodi	A12B1S11
Fuqia	16A-(250VAC)
Dalja	4P me dritë
Çmim	

IP20



Kodi	A12W1K11
Fuqia	16A-(250VAC)
Dalja	4P me dritë
Çmim	

IP20



Kodi	A14B1H10
Fuqia	16A-(250VAC)
Dalja	4P pa dritë
Çmim	

IP20



Kodi	A14B1K11
Fuqia	16A-(250VAC)
Dalja	4P me dritë
Çmim	

IP20



Kodi	A14B1S11
Fuqia	16A-(250VAC)
Dalja	4P me dritë
Çmim	

IP20



Kodi	A14W1K11
Fuqia	16A-(250VAC)
Dalja	4P me dritë
Çmim	

IP65



Kodi	A54B1H10
Fuqia	16A-(250VAC)
Dalja	4P pa dritë
Çmim	

IP65



Kodi	A54B1K11
Fuqia	16A-(250VAC)
Dalja	4P me dritë
Çmim	

IP65



Kodi	A54B1S11
Fuqia	16A-(250VAC)
Dalja	4P me dritë
Çmim	

IP65



Kodi	A54B1Y11
Fuqia	16A-(250VAC)
Dalja	4P me dritë
Çmim	



Kodi AL107
Fuqia 16A-(250VAC)
Dalja 6P pa dritë
Çmim



Kodi AL104A
Fuqia 16A-(250VAC)
Dalja 6P me dritë
Çmim



IP65

Kodi AL108W
Fuqia 16A-(250VAC)
Dalja 6P pa dritë
Çmim



Kodi AL105
Fuqia 16A-(250VAC)
Dalja 6P me dritë
Çmim



Kodi AL104S
Fuqia 30A-(250VAC)
Dalja 4P me dritë
Çmim



IP65

Kodi AL104WS
Fuqia 30A-(250VAC)
Dalja 4P me dritë
Çmim



Kodi AL121
Fuqia 6A-(250VAC)
Dalja 3P pa dritë
Çmim



Kodi AL118
Fuqia 6A-(250VAC)
Dalja 3P me dritë
Çmim



Kodi AL123
Fuqia 6A-(250VAC)
Dalja 3P pa dritë
Çmim



Kodi AL115
Fuqia 16A-(250VAC)
Dalja 3P pa dritë
Çmim



Kodi AL134
Fuqia 6A-(250VAC)
Dalja 3P pa dritë
Çmim



Kodi AL119
Fuqia 6A-(250VAC)
Dalja 4P
Çmim



Kodi AL131W
Fuqia 6A-(250VAC)
Dalja 3P me dritë
Çmim



Kodi AL117B
Çmim



Kodi AL112
Çmim



Kodi AL135
Fuqia 15A-(250VAC)
Dalja 9P me dritë
Çmim



Me rikthim

Kodi AL109A
Fuqia 16A-(250VAC)
Dalja 6P pa dritë
Çmim



Me rikthim

Kodi AL117
Fuqia 15A-(250VAC)
Dalja 3P pa dritë
Çmim



Me rikthim

Kodi AL123A
Fuqia 6A-(250VAC)
Dalja 3P pa dritë
Çmim



Me rikthim

Kodi AL111
Fuqia 16A-(250VAC)
Dalja 6P pa dritë
Çmim

Llampë pilot 220 V AC

Kodi	S100N*
Fuqia	220V AC
Dalja	2P /fi10mm
Çmim	

Llamb pilot 24 V AC/DC

Kodi	S100L*2
Fuqia	24V AC/DC
Dalja	2P /fi10mm
Çmim	

Llamb pilot 12V AC/DC

Kodi	S100L*1
Fuqia	12V AC/DC
Dalja	2P /fi10mm
Çmim	

Llamb pilot 220 V AC

Kodi	AL227
Fuqia	220V AC
Dalja	2P /fi10mm
Çmim	

10mm Metalik

Kodi	AL179
Fuqia	0.5A-(250VAC)
Dalja	2P
Çmim	

12mm Plastik

Kodi	AL191
Fuqia	2A-(250VAC)
Dalja	2P
Çmim	

16mm Metalik

Kodi	AL180
Fuqia	3A-(250VAC)
Dalja	2P
Çmim	

16mm Plastik

Kodi	AL180A
Fuqia	3A-(250VAC)
Dalja	2P
Çmim	

16mm 12V-220V

Kodi	AL180B/C
Fuqia	3A-(250VAC)
Dalja	4P
Çmim	

22mm Plastik - Rikthim

Kodi	AL180A-1
Fuqia	6A-(250VAC)
Dalja	2P
Çmim	

22mm Metalik - Rikthim

Kodi	AL180-1
Fuqia	16A-(250VAC)
Dalja	2P
Çmim	

25mm Llamb 12V

Kodi	PS1816N2
Fuqia	16A-(250VAC)
Dalja	4P
Çmim	

Metalik 19mm Rrumbullak

Kodi	AL181
Fuqia	3A-(250VAC)
Dalja	2P
Çmim	

Metalik 19mm i dale

Kodi	AL182H
Fuqia	3A-(250VAC)
Dalja	2P
Çmim	

Metalik 22mm i drejte

Kodi	D89
Fuqia	3A-(250VAC)
Dalja	2P
Çmim	

Metalik 19mm

Kodi	GQ-22D
Fuqia	3A-(250VAC)
Dalja	2P
Çmim	

Metalik 22mm

Kodi	D22F11M
Fuqia	16A-(250VAC)
Dalja	6P
Çmim	

22mm me led 12 V rikthim

Kodi	D22F11EM
Fuqia	16A-(250VAC)
Dalja	6P / LED
Çmim	

22 mm me led 12 V ndalim

Kodi	D22F11EL
Fuqia	16A-(250VAC)
Dalja	6P /LED
Çmim	

12mm nderpreres kembe

Kodi	AL148J
Fuqia	2A-(250VAC)
Dalja	2P/ OFF- (ON)
Çmim	

2

ÇELËSA START/STOP
PËR AUTOMJETE

Mikro celes me drite

Kodi	AL118A
Fuqia	15A-(12V DC)
Dalja	3P
Çmim	

Celes ON-OF 25mm

Kodi	AL132D
Fuqia	25A-(12V DC)
Dalja	3P
Çmim	

Celes tek lekundes

Kodi	ASW-09D
Fuqia	20A-(12V DC)
Dalja	3P
Çmim	

19mm me qendrim IP67

Kodi	AL180W
Fuqia	20A-12V DC
Dalja	2P
Çmim	

22 mm me drite IP67

Kodi	KCD2201NM
Fuqia	20A-12V DC
Dalja	3P / LED
Çmim	

Koka 43mm

Kodi	AL180J
Fuqia	6A-(250VAC)
LED	Me led 12V
Çmim	

Buton xhama makine

Kodi	ASW-09D
Fuqia	20A-(12V DC)
Dalja	5P
Çmim	

Celes Marine

Kodi	AL134M
Fuqia	20A-12V DC
Dalja	3P
Çmim	

Celes Ndezës motori

Kodi	ASWB-05
Fuqia	50A-(12VDC)
Dalja	2P
Çmim	

Celes Tumbler on-off

Kodi	101AAWPC
Fuqia	30A-12V DC
Dalja	2P
Çmim	

12 mm me drite

Kodi	AL151A
Fuqia	20A-12V DC
Dalja	3P / LED
Çmim	

10mm Metalik

Kodi	AL151B
Fuqia	30A-12V DC
Dalja	3P / LED
Çmim	

Celes Ndezës motori 22mm

Kodi	A223B07
Fuqia	50A-12V DC
Dalja	3P
Çmim	

Celes on-off 12mm

Kodi	R13401101
Fuqia	50A-12V DC
Dalja	2P
Çmim	

Celes on-off 12mm IP65

Kodi	R13501101
Fuqia	50A-12V DC
Dalja	2P / IP65
Çmim	

Celes on-off 12mm

Kodi	R13401103
Fuqia	50A-12V DC
Dalja	3P
Çmim	

Voltmeter 28 mm

Kodi	AL230D
Shkalla	8-32V DC
Dalja	2P
Çmim	

Ampermetër 29 mm 0-10A

Kodi	AL230DA
Shkalla	5-48V DC
Dalja	3P
Çmim	

Nderpreres - Bashkues kabelli

Kodi	201NWSB
Fuqia	30A-12V DC
Dalja	4P
Çmim	

Nderpreres baterie 240 AMP

Kodi	RL240ARC
Fuqia	240A DC
Voltazh	12 V DC
Çmim	

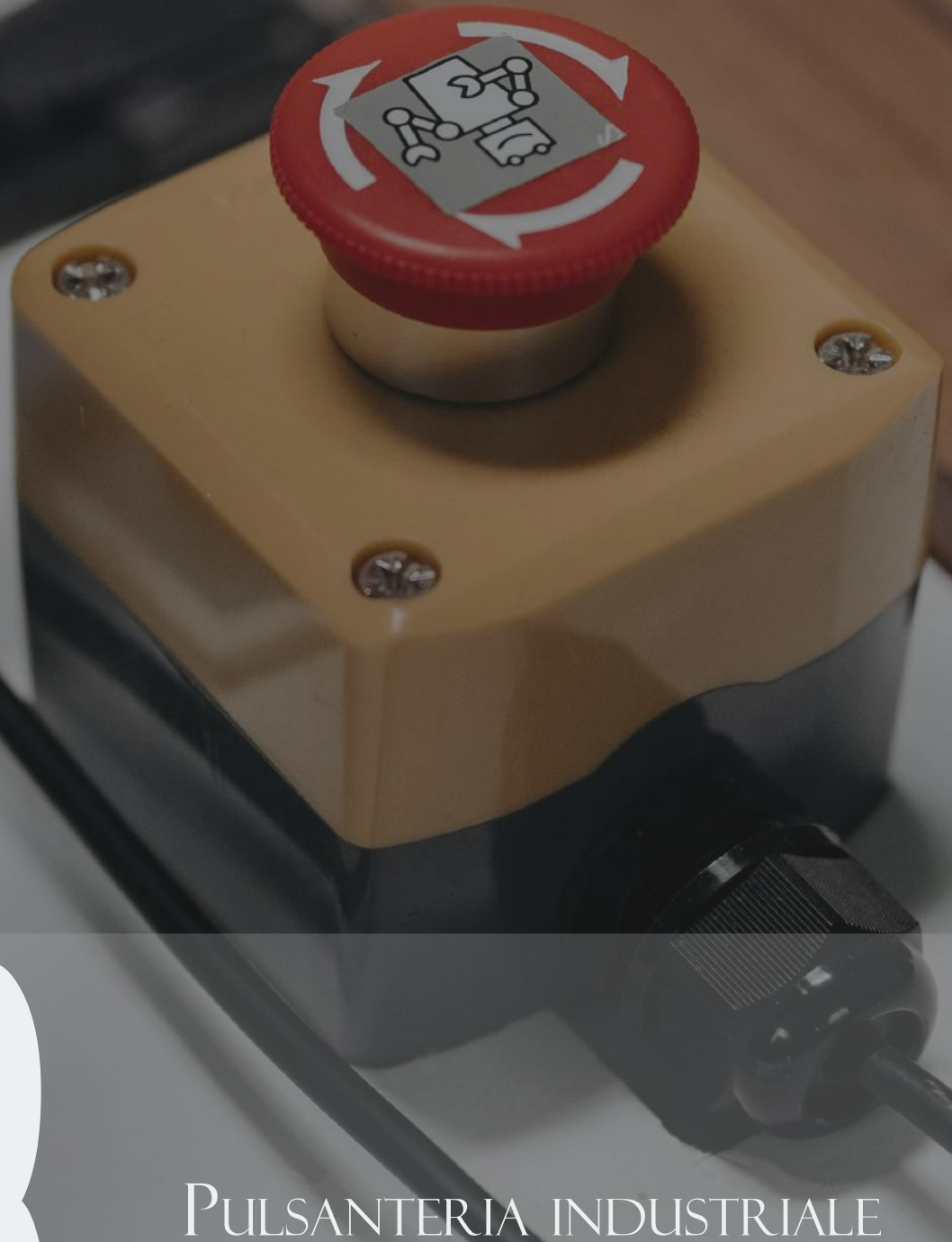

B

PULSANTERIA INDUSTRIALE

GWEST

Llamba dhe sinjalizues paneli IP50



LLamb paneli fi 22 220V AC/DC IP50					
Kodi	Ngjyra	Voltazhi	Ø mm	Paketimi	Çmimi
22Y	JESHILE	220 V AC/DC	22	10 copë	
22K	E KUQE	220 V AC/DC	22	10 copë	
22S	E VERDHE	220 V AC/DC	22	10 copë	
22M	BLU	220 V AC/DC	22	10 copë	



LLamb paneli fi 22 24V AC/DC IP50					
Kodi	Ngjyra	Voltazhi	Ø mm	Paketimi	Çmimi
22-24VY	JESHILE	24 V AC/DC	22	10 copë	
22-24VK	E KUQE	24 V AC/DC	22	10 copë	
22-24VS	E VERDHE	24 V AC/DC	22	10 copë	
22-24VM	BLU	24 V AC/DC	22	10 copë	



LLamb paneli fi 22 110V AC/DC IP50					
Kodi	Ngjyra	Voltazhi	Ø mm	Paketimi	Çmimi
22-110VY	JESHILE	110 V AC/DC	22	10 copë	
22-110VK	E KUQE	110 V AC/DC	22	10 copë	
22-110VS	E VERDHE	110 V AC/DC	22	10 copë	
22-110VM	BLU	110 V AC/DC	22	10 copë	

GWEST

Voltmeter, ampermeter dhe buzera



Voltmeter 24-550V AC IP50					
Kodi	Ngjyra	Voltazhi	Ø mm	Paketimi	Çmimi
22VSY	JESHILE	24-550V	22	10 copë	
22VSK	E KUQE	24-550V	22	10 copë	
22VSS	E BARDH	24-550V	22	10 copë	



Ampermeter 0-100A AC IP50					
Kodi	Ngjyra	Voltazhi	Ø mm	Paketimi	Çmimi
22ASY	JESHILE	0-100A	22	10 copë	
22ASK	E KUQE	0-100A	22	10 copë	
22ASS	E BARDH	0-100A	22	10 copë	



Buzer vizual dhe zanorë IP50					
Kodi	Ngjyra	Voltazhi	Ø mm	Paketimi	Çmimi
22DS/MS	E KUQE	220V AC	22	10 copë	
22DS/MS24	E KUQE	24V AC/DC	22	10 copë	

Buton paneli pa dritë dhe me dritë IP50

Kodi	Ngjyra	Lloji	Kontakti	Çmimi
A510	JESHILE	Y	Me rikthim	1NO
A501	E KUQE	K	Me rikthim	1NC
A511	E VERDHE	S	Me rikthim	1NO
A510/1	JESHILE	I	Me rikthim	1NO
A501/2	E KUQE	O	Me rikthim	1NC
A510/3	E BARDHE	↑	Me rikthim	1NO
A510/4	E ZEZE	↑	Me rikthim	1NO
A510D	JESHILE	Y	Me rikthim LED	1NO
A501D	E KUQE	K	Me rikthim LED	1NC
A511D	E VERDHE	S	Me rikthim LED	NO

Celës komandimi pa dritë

Kodi	Pozicioni	Kontakti	Paketimi	Çmimi
A510X	0-1	1NO	10 COPE	
A520XS	1-0-2	2NO	10 COPE	
A510XF	0-(1)	1NO RIKTHIM	10 COPE	
A520XF	1-0-(2)	2NO 1-RIKTHIM	10 COPE	
A520XFU	(1)-0-(2)	2NO RIKTHIM	10 COPE	

Celës komandimi me dritë

Kodi	Pozicioni	Kontakti	Paketimi	Çmimi
A510XD	0-1	1NO+LED	10 COPE	
A501XD	0-1	1NC+LED	10 COPE	
A520XD	1-0-2	2NO-LED	10 COPE	
A502XD	1-0-2	2NC+LED	10 COPE	

Celës komandimi pa dritë me celës

Kodi	Pozicioni	Kontakti	Paketimi	Çmimi
A5-10Y	0-1	1NO	10 COPE	
A5-20YS	1-0-2	2NO	10 COPE	

Buton start-stopi me dritë dhe pa dritë IP50

Kodi	Lloji	Kontakti	Paketimi	Çmimi
A5-11R	PA DRITE	1NO+1NC	10 COPE	
A5-11RD	ME DRITE	1NO+1NC	10 COPE	
A5-11RD24	ME DRITE	1NO+1NC	10 COPE	
LAY5-EL8325	DREJTEKENDESH	1NO+1NC	10 COPE	

Potasiometër 5 dhe 10 K om

Kodi	Voltazhi	Lloji	Shkalla	Paketimi	Çmimi
APT22-5K	220V	5K	10	10 COPE	
APT22-10K	220V	10K	10	10 COPE	



GWEST

Butona emergjence dhe kuti për komandimin



Kodi	Lloji	Kontakti	Paketimi	Çmimi
A5 - 01ZS	Buton Emergjence	K 1NC	10 COPE	



Kodi	Lloji	Kontakti	Paketimi	Çmimi
BZ - 01ZA	Buton Emergjence	K 1NC	10 COPE	



Kodi	Lloji	Kontakti	Paketimi	Çmimi
A5 - 01M	BUTON STOP	K 1NC	10 COPE	
A5 - 10M	BUTON START	Y 1NO	10 COPE	



Kodi	Lloji	Kontakti	Paketimi	Çmimi
LAY2-KSE542	KUTI+ Buton Emergjence	1NC	10 COPE	



Kodi Çmimi
GBK-1



Kodi Çmimi
GBK-2



Kodi Çmimi
GBK-3



Kodi Çmimi
GBK-4



Kodi Çmimi
GBK-5



Kodi Çmimi
GBK-6

Kontakt i hapur GWEST

Kodi	A10
Kontakti	NO
Çmimi	

Kontakt i mbyllur GWEST

Kodi	A01
Kontakti	NC
Çmimi	

Kontakt Drite GWEST

Kodi	AD2
Lloji	Pa llambë
Çmimi	

Llamb led pulsanterie

Kodi	BA9SC-*
Voltazhi	220V AC
Ngjyrat	Y K S
Çmimi	

Llamb led pulsanterie

Kodi	BA9SC-24*
Voltazhi	220V AC
Ngjyrat	Y K S
Çmimi	

Llamb led pulsanterie

Kodi	BA9SC-110*
Voltazhi	220V AC
Ngjyrat	Y K S
Çmimi	

Etiket emertimi pulsanterie

Kodi	FC
Diametri	22 mm
Çmimi	

Mbrojtese plastike butoni

Kodi	FH
Diametri	22 mm
Çmimi	

Gomine butoni

Kodi	BK
Diametri	22 mm
Çmimi	

Kontakt

Kodi	AKS01
Kontakti	1 NC
Fuqja	16A (250V AC)
Çmimi	

Kontakt

Kodi	AKS01
Kontakti	1 NC
Fuqja	16A (250V AC)
Çmimi	

Emertues emergjence

Kodi	HD60
Diametri	22mm
Diametri ja	60mm
Çmimi	

Rele, nderpres rryme

Kodi	AL271S
Fuqja	8A deri 25A
Voltazhi	12-250V AC/DC
Çmimi	

Rele, nderpres rryme

Kodi	ST2A
Fuqja	10A-20A
Voltazhi	12-250V AC/DC
Çmimi	

Rele, nderpres rryme

Kodi	ST2P
Fuqja	10A-50A
Voltazhi	12-250V AC/DC
Çmimi	

Butona paneli monoblok 22mm IP50

MB100DK



MB100HS



MB100FY

Lloji	Kontakti	Ngjyra	Paketimi	Kodi	Çmimi
Me rikthim	1NO	Y	10 COPE	MB100D	
	2NO			MB101D	
	1NO+NC	MB102D			
	1NC	MB200D			
	2NC	MB202D			
Me rikthim i dalë	1NO	S	10 COPE	MB100H	
	2NO	M		MB101H	
	1NO+NC			MB102H	
	1NC	B		MB200H	
	2NC	H		MB202H	
Me qendrim	1NO	H	10 COPE	MB100F	
	1NC			MB200F	
	2NO			MB101F	
	1NO+1NC			MB102F	

Per kodin perfundimtar te artikullit vendosni shkronjen qe i korespondon butonit me ngjyren qe doni

Çelës selektor paneli monoblok 22mm IP50

Lloji	Kontakti	Paketimi	Kodi	Çmimi
0-1	1NO	10 COPE	MB100S20	
1-0-2	2NO		MB101S30	
0-(1) me rikthim	1NO		MB100S20	
1-0-(2) me 1 rikthim	2NO		MB101S31	
(1)-0-(2) me rikthim	2NO		MB101S32	

Llampe paneli monoblok 22mm IP50

Lloji	Kontakti	Paketimi	Ngjyra	Çmimi
MBSD012*	12V AC/DC	10 COPE	K M S Y	
MBSD024*	24V AC/DC		K M S Y	
MBSD110*	110V AC		K M S Y	
MBSD220*	220V AC		K M S Y	

Potasiometra

Lloji	Lloji	Grafiku	Paketimi	Kodi	Çmimi
10	1 kΩ	10 MΩ min. (500V DC)	10 COPE	BPR01K	
	2,2 kΩ			BPR02K	
	5 kΩ			BPR05K	
	10 kΩ			BPR10K	
	100 kΩ			BPR0100K	

Butona paneli seria B 22mm IP50

Lloji	Kontakti	Ngjyra	Paketimi	Kodi	Çmimi
Me rikthim	1NO	Y	10 COPE	B100D*	
	2NO			B101D*	
	1NO+NC			B102D*	
	1NC	K		B200D*	
	2NC	B202D*			
Me rikthim i dalë	1NO	S	10 COPE	B100H*	
	2NO	M		B101H*	
	1NO+NC	B		B102H*	
	1NC	H		B200H*	
	2NC	B202H*			
Me Qendrim	1NO		10 COPE	B100F*	
	1NC			B200F*	

Butona paneli seria CP 22mm IP65

Lloji	Kontakti	Ngjyra	Paketimi	Kodi	Çmimi
Me rikthim	1NO	Y	10 COPE	CP100D*	
	2NO			CP101D*	
	1NO+NC			CP102D*	
	1NC	K		CP200D*	
	2NC	CP202D*			
Me rikthim i dalë	1NO	S	10 COPE	CP100H*	
	2NO	M		CP101H*	
	1NO+NC	B		CP102H*	
	1NC	H		CP200H*	
	2NC	CP202H*			
Me qendrim	1NO		10 COPE	CP100F*	
	1NC			CP200F*	

Butona paneli seria CM metalike 22mm IP65

Lloji	Kontakti	Ngjyra	Paketimi	Kodi	Çmimi	
Me rikthim	1NO	Y	10 COPE	CM100D*		
	2NO			K		CM101D*
	1NO+NC			S		CM102D*
	1NC	M		CM200D*		
	2NC	B		CM202D*		
	2NO+2NC	H		CM305D*		





Butona start-stopi me rikthim, seria B IP50, ka dhe kontaktin e led			
Ngjyra	Kontakti	Kodi	Çmimi
BARDH E ZI	1 NO + 1 NC	B132K21HB	
I KUQ ME JESHIL	1 NO + 1 NC	B132K21KY	



Butona start-stopi me rikthim seria CP, IP65			
Ngjyra	Kontakti	Kodi	Çmimi
BARDH E ZI	1 NO + 1 NC	CP102K20HB	
I KUQ ME JESHIL	1 NO + 1 NC	CP102K20KY	



Butona start-stopi me rikthim seria B, IP50			
Ngjyra	Kontakti	Kodi	Çmimi
BARDH E KUQ	1 NO + 1 NC+ 1NO	B121B30BB	
I KUQ ME JESHIL	1 NO + 1 NC+ 1NO	B121B30YY	



Butona metalike start-stopi me rikthim seria CM, IP65			
Ngjyra	Kontakti	Kodi	Çmimi
BARDH E KUQ	1 NO + 1 NC	CM102K20HB	
I KUQ ME JESHIL	1 NO + 1 NC	CM102K20KY	



Butona metalike start-stopi me rikthim seria CM, IP65			
Ngjyra	Kontakti	Kodi	Çmimi
POSHT-LART	2NO	CM101K20YYOK	
I - II	2NO	CM101K20YY12	





Buton per 4 dhe 5 kontakte me bobin per sharra elektrike					
Lloji	Kontakti	AC-1	AC-3	Kodi	Çmimi
Me Bobin	4CO	18 A	15 A	KJD17BC1	
	4CO+T	18 A	15 A	KJD17BC1T	

Celes komandimi seria CB IP65, kesaj seria mund ti shtoni kontaktin e drites

Pozicioni	Kontakti	Paketimi	Kodi	Çmimi
0-1	1NO		CP100S20	
0-1 rikthim	1NO		CP100S21	
1-0-2	2NO	10 COPE	CP101S30	
1-0-(2) me 1 rikthim	2NO		CP101S31	
(1)-0-(2) me rikthim	2NO		CP101S32	
1-0-2	2NO+2NO	5 COPE	CP303S30	
1-0-2	2NO+2NC		CP305S30	

Celes komandimi seria B IP50 , kesaj seria mund ti shtoni kontaktin me driten led

Pozicioni	Kontakti	Ngjyra	Kodi	Çmimi
0-1	1NO		B100SL20*	
0-(1) rikthim	1NO		B100SL21*	
1-0-2	2NO		B101SL30*	
1-0-(2) me 1 rikthim	2NO		B101SL31*	
(1)-0-(2) me rikthim	2NO		B101SL32*	

Celes komandimi metalike seria CM IP65 , kesaj serie mund ti shtoni kontaktin e drites

Pozicioni	Kontakti	Paketimi	Kodi	Çmimi
0-1	1NO		CM100S20	
0-1 rikthim	1NO		CM100S21	
1-0-2	2NO	10 COPE	CM100S30	
1-0-(2) me 1 rikthim	2NO		CM100S31	
(1)-0-(2) me rikthim	2NO		CM100S32	
1-0-2	2NO+2NO	5 COPE	CM303S30	

Celes komandimi seria B me celes IP50

Pozicioni	Kontakti	Paketimi	Kodi	Çmimi
0-1	1NO		B100AA20	
0-1 rikthim	1NO	10 COPE	B100AA21	
1-0-2	2NO		B101AA30	

Celes komandimi metalike seria CM me celes IP65

Pozicioni	Kontakti	Paketimi	Kodi	Çmimi
0-1	1NO		CM100AA20	
0-1 rikthim	1NO	10 COPE	CM100AA21	
1-0-2	2NO		CM101AA30	



Butona emergjence seria B, IP50

Koka	Kontakti	Funksioni	Kodi	Çmimi
40 mm	1NC	Me rrotullim	B200E	
40 mm	1NC		B200EE	
30 mm	1NC		B200E30	
60 mm	1NC		B200E60	

Butona emergjence seria CP, IP65

Koka	Kontakti	Funksioni	Kodi	Çmimi
30 mm	1NC	Me rrotullim	CP200E30	
40 mm	1NC	me çelës	CP200E	
30 mm	1NC		CP200EA30	

Butona emergjence metalike seria CM, IP65

Koka	Kontakti	Funksioni	Kodi	Çmimi
40 mm	1NC	Me rrotullim	CM200E	
40 mm	1NC		CM200EE	
30 mm	1NC		CM200EK30	

Leve komandimi struktur plastike seria CP, IP65

Koka	Kontakti	Funksioni	Kodi	Çmimi
Me qendrim	1NO+1NO	2	CP101DJ21	
Me rikthim	1NO+1NO	2	CP101DJ21	
Me qendrim	2NO+2NO	4	CP707DJ40	
Me rikthim	2NO+2NO	4	CP707DJ41	

Leve komandimi struktur metalike seria CM, IP65

Koka	Kontakti	Funksioni	Kodi	Çmimi
Me qendrim	1NO+1NO	2	CM101DJ20	
Me rikthim	1NO+1NO	2	CM101DJ21	
Me qendrim	2NO+2NO	4	CM707DJ40	
Me rikthim	2NO+2NO	4	CM707DJ41	



Kodi P1EC400E40K
Cmimi



Kodi P1EC400E72
Cmimi



Kodi M1C200E40
Cmimi



Kodi PIC300DY
Cmimi



Kodi PIC304K20
Cmimi



Kodi PIC304DK
Cmimi



Kodi P3C1A2BE30
Cmimi



Kodi P2AB
Cmimi



Kodi P32C1B
Cmimi



Kodi PA2BOSP
Cmimi



Kodi PA3BOS
Cmimi



Kodi PA4BOS
Cmimi



Kodi PA5BOS
Cmimi



Kodi PA9BOS
Cmimi



Kodi PA8BOS
Cmimi



Kodi B1
Cmimi



Kodi B2
Cmimi



Kodi C3BK
Cmimi



Kodi C4BK
Cmimi



Kodi C1
Cmimi



Kodi C2
Cmimi



Kodi C3CK
Cmimi



Kodi C4CK
Cmimi



Kodi C11
Cmimi



Kodi C12
Cmimi



Kodi B3
Cmimi



Kodi BK
Cmimi



Kodi CA
Cmimi



Kodi BEBK20
Cmimi



Kodi BEB
Cmimi



Kodi CEB
Cmimi



Kodi BROZET08
Cmimi



Kodi BROZET18
Cmimi



Kodi LED024
Cmimi



Kodi LED220
Cmimi



Kodi EMNKAPAK
Cmimi



Kodi BSTORAGE
Cmimi



Kodi BET60P
Cmimi



Kodi BARP
Cmimi

Llampë sinjalizues paneli FI 22 MM

Kodi	Ngjyra	Voltazhi	Ø mm	Paketimi	Çmimi
AD-22-22BS	G	220 V AC	22	10 copë	
AD-22-22BS	R	220 V AC	22	10 copë	
AD-22-22BS	Y	220 V AC	22	10 copë	

Voltmeter, Ampermeter, Frekuencë meter

Kodi	Emertimi	Voltazhi	Paketimi	Çmimi
AD16-22DV	VOLTMETER	20-500V AC	10 copë	
AD16-22DA	AMPERMETER	0-100V AC	10 copë	
AD16-22DHz	FREKUENCE M	0-99Hz	10 copë	
AD16-22VA	VOLT + AMPER	50-500V 100A	10 copë	

Buton stopi dhe Emergjence metalike FI 22mm

Kodi	Emertimi	Kontakti	Ø mm	Paketimi	Çmimi
LAY4-BC42	BUTON	1 NC	22	10 copë	
LAY4-BS542	BUTON EMERG- JENCE	1 NC	22	10 copë	
LAY4-BS142	BUTON EMERG- JENCE	1 NC	22	10 copë	

Buton start stopi metalike FI 22mm

Kodi	Ngjyra	Kontakti	Ø mm	Paketimi	Çmimi
LAY4-BL8425	PA LE	1 NO + 1NC	22	10 copë	
LAY4-BL8465	ME LED	1 NO + 1NC	22	10 copë	

Çeles komandimi start stop 3 fazore

Kodi	Fuqia	Fazët	Përmasat	Çmimi
BS-211	1.5 KW 500 V	10A 3 POLE	42X80X42 mm	
BS-216	2.2 KW 500 V	16A 3 POLE	42X80X42 mm	
BS-230	7.5 KW 500 V	30A 3 POLE	55X97X50 mm	

Leve komandimi metalike me 2 dhe 4 pozicione

Kodi	Lloji	Pozicione	Kontakti	Çmimi
LAY5-B2-PA12	ME QENDRIM	2	1NO+1NO	
LAY5-B2-PA22	ME RIKTHIM	2	1NO+1NO	
LAY5-B2-PA14	ME QENDRIM	4	2NO+2NO	
LAY5-B2-PA24	ME RIKTHIM	4	2NO+2NO	





LAY4-BV64

Llampë Sinjalizues Paneli seria LAY4 metalik me kontakt drite led

Kodi	Ngjyra	Voltazhi	Ø mm	Paketimi	Çmimi
LAY4-BV63	G	220 V AC	22	10 copë	
LAY4-BV64	R	220 V AC	22	10 copë	
LAY4-BV65	Y	220 V AC	22	10 copë	
LAY4-BV66	B	220 V AC	22	10 copë	



LAY4-BA31

Butona Paneli metalikë seria LAY4

Kodi	Ngjyra	Voltazhi	Ø mm	Paketimi	Çmimi
LAY4-BA31	G	NO	22	10 copë	
LAY4-BA42	R	NC	22	10 copë	
LAY4-BA51	Y	NO	22	10 copë	
LAY4-BP31	IP65 G	NO	22	10 copë	
LAY4-BP42	IP65 R	NC	22	10 copë	
LAY4-BP51	IP65 Y	NO	22	10 copë	



LAY4-BA3341

Butona Paneli metalikë me sinjalistikë seria LAY4

Kodi	Ngjyra	Kontakti	Ø mm	Paketimi	Çmimi
LAY4-BA3311	I	NO	22	10 copë	
LAY4-BA3341	↑	NO	22	10 copë	
LAY4-BA3351	↑	NO	22	10 copë	
LAY4-BA4322	⊙	NC	22	10 copë	



LAY4-BD21

Çelësa Paneli metalikë seria LAY4

Kodi	Pozicioni	Kontakti	Ø mm	Paketimi	Çmimi
LAY4-BD21	0-1	1 NO	22	10 copë	
LAY4-BD41	0-1 RIKTHIM	1 NO	22	10 copë	
LAY4-BD33	1-0-2	2 NO	22	10 copë	

Çelësa Paneli metalikë me ndricim LED seria LAY4

Kodi	Pozicioni	Kontakti	Ø mm	Paketimi	Çmimi
LAY4-BK123	0-1	1 NO	22	10 copë	
LAY4-BK133	1-0-2	2 NO	22	10 copë	



LAY4-BG33

Celësa Paneli metalike me Celes seria LAY4

Kodi	Pozicioni	Kontakti	Ø mm	Paketimi	Çmimi
LAY4-BG41	0-1	1 NO	22	10 copë	
LAY4-BG33	1-0-2	2 NO	22	10 copë	



4

SINJALIZUES TË NDRYSHËM



me buzzer

Kodi	Lloji	Voltazhi	Çmimi
IK51L220XM03	LED	220AC	
IK52L220XM03	LED	220AC	
IK53L220XM03	LED	220AC	
IK51L024XM03	LED	24V AC/DC	
IK52L024XM03	LED	24V AC/DC	
IK53L024XM03	LED	24V AC/DC	
IK51F220XM03	PULSUES LED	220AC	
IK52F220XM03	PULSUES LED	220AC	
IK53F220XM03	PULSUES LED	220AC	
IK51F024XM03	PULSUES LED	24V AC/DC	
IK52F024XM03	PULSUES LED	24V AC/DC	
IK53F024XM03	PULSUES LED	24V AC/DC	

Kodi	Lloji	Voltazhi	Çmim
IK51L220ZM03	LED	220AC	
IK52L220ZM03	LED	220AC	
IK53L220ZM03	LED	220AC	
IK51L024ZM03	LED	24V AC/DC	
IK52L024ZM03	LED	24V AC/DC	
IK53L024ZM03	LED	24V AC/DC	
IK51F220ZM03	PULSUES LED	220AC	
IK52F220ZM03	PULSUES LED	220AC	
IK53F220ZM03	PULSUES LED	220AC	
IK51F024ZM03	PULSUES LED	24V AC/DC	
IK52F024ZM03	PULSUES LED	24V AC/DC	
IK53F024ZM03	PULSUES LED	24V AC/DC	



IT120R024

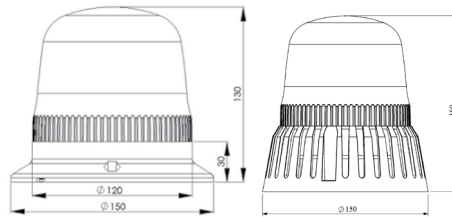

IT120R024Z



IT070R024Z

Kodi	Lloji	Voltazhi	Ngjyra	Buzzer	Çmim
IT070R024Z	LED	12-24V AC/DC	R	✓	
IT070R240Z	LED	48-240V AC/DC	R	✓	
IT070Y024Z	LED	12-24V AC/DC	Y	✓	
IT070Y240Z	LED	48-240V AC/DC	Y	✓	
IT070G024Z	LED	12-24V AC/DC	G	✓	
IT070G240Z	LED	48-240V AC/DC	G	✓	
IT070R024C	LED	12-24V AC/DC	R	✓	
IT070R230C	LED	230V AC	R	✓	
IT120R024	LED	12-24V AC/DC	R		
IT120R024Z	LED	12-24V AC/DC	R	✓	
IT120R048	LED	48V AC	R		
IT120R220	LED	110-220V AC	R		
IT120R220Z	LED	110-220V AC	R	✓	

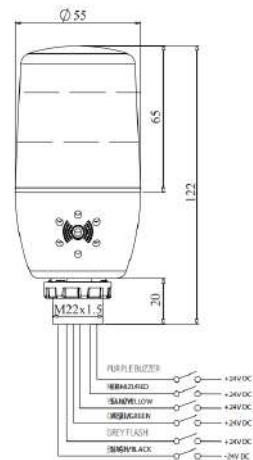

Kodi	Lloji	Voltazhi	Çmimi
IF5T024ZM05	LED-3 Ngjyra-Buzzer PLC Support	24V DC	

Llampa për sinjalizues tower

Voltazhi	Me led	Ngjyra	Çmimi
24V AC/DC	IKML024*	B Y K S M	
110V AC	IKML110*	B Y K S M	
220V AC	IKML220*	B Y K S M	



Voltazhi	Led pulsues	Ngjyra	Çmimi
24V AC/DC	IKMF024*	B Y K S M	
110V AC	IKMF110*	B Y K S M	
220V AC	IKMF220*	B Y K S M	



Trupi dhe coveri

Kodi	Çmimi
IKM5G Dia 50 mm	
IKM7G Dia 70mm	



Sinjale per tower

Kodi	Lloji	Çmimi
IKM5* 50 mm	Polikarbonat - rezistent ndaj nxehtesise	
IKM7* 70 mm	Polikarbonat - rezistent ndaj nxehtesise	



Buzera per tower

Kodi	Lloji	Çmimi
IKM5Z024	50 mm / 90 dB	
IKM5Z110	50 mm / 90 dB	
IKM5Z220	50 mm / 90 dB	
IKM7Z024	70 mm / 90 dB	
IKM7Z110	70 mm / 90 dB	
IKM7Z220	70 mm / 90 dB	





LTE-1081-220ACY

Drite rrotulluese IP55 , FI 80mm me dhe pa buzër				
Kodi	Përshkrimi	Voltazhi	Fuqia	Çmimi
LTE-1081-220AC*	Drite rrotuluese	220V AC	5W	
LTE-1081J-220AC*	Drite rrotuluese me buzër	220V AC	5W	
LTE-1081-12VDC*	Drite rrotuluese	12V DC	5W	
LTE-1081J-12VDC*	Drite rrotuluese me buzër	12VDC	5W	
LTE-1081 -24VAC*	Drite rrotuluese	24V AC	5W	
LTE-1081J-24VAC*	Drite rrotuluese me buzër	24V AC	5W	
LTE-1081 -24VDC*	Drite rrotuluese	24V DC	5W	
LTE-1081J-24VDC*	Drite rrotuluese me buzër	24V DC	5W	



LTD-1081-220ACR

Drite rrotulluese me magnet IP55 , FI 80mm me dhe pa buzër				
Kodi	Përshkrimi	Voltazhi	Fuqia	Çmimi
LTD-1081-220AC*	Drite rrotuluese	220V AC	5W	
LTD-1081J-220AC*	Drite rrotuluese me buzër	220V AC	5W	
LTD-1081-12VDC*	Drite rrotuluese	12V DC	5W	
LTD-1081J-12VDC*	Drite rrotuluese me buzër	12VDC	5W	
LTD-1081 -24VAC*	Drite rrotuluese	24V AC	5W	
LTD-1081J-24VAC*	Drite rrotuluese me buzër	24V AC	5W	
LTD-1081 -24VDC*	Drite rrotuluese	24V DC	5W	
LTE-1081J-24VDC*	Drite rrotuluese e verdhë me buzër	24V DC	5W	



LTD-1122J-220ACR

Drite rrotulluese me magnet IP55 , FI 120mm me dhe pa buzër				
Kodi	Përshkrimi	Voltazhi	Fuqia	Çmimi
LTD-1122-220AC*	Drite rrotuluese	220V AC	10W	
LTD-1122J-220AC*	Drite rrotuluese me buzër	220V AC	10W	
LTD-1122-12VDC*	Drite rrotuluese	12V DC	10W	
LTD-1122J-12VDC*	Drite rrotuluese me buzër	12V DC	10W	
LTD-1122 -24VAC*	Drite rrotuluese	24V AC	10W	
LTD-1122J-24VAC*	Drite rrotuluese me buzër	24V AC	10W	
LTD-1122 -24VDC*	Drite rrotuluese	24V DC	10W	
LTD-1122J-24VDC*	Drite rrotuluese me buzër	24V DC	10W	



LTD-1201-12VDCR

Drite rrotulluese me magnet IP55 , FI 185mm me dhe pa buzër				
Kodi	Përshkrimi	Voltazhi	Fuqia	Çmimi
LTD-1201-12VDC*	Drite rrotuluese	12V DC	23W	
LTD-1201J-12VDC*	Drite rrotuluese me buzër	12V DC	23W	
LTD-1201 -24VDC*	Drite rrotuluese	24V DC	23W	
LTD-1201J-24VDC*	Drite rrotuluese me buzër	24V DC	23W	



Sirenë alarmi					
Kodi	Ngjyra	Voltazhi	Ø mm	Akustika	Çmimi
MS190	E kuqe	220V AC	75	110-130 dB	
MS190-24	E kuqe	24V AC/DC	75	110-130 dB	

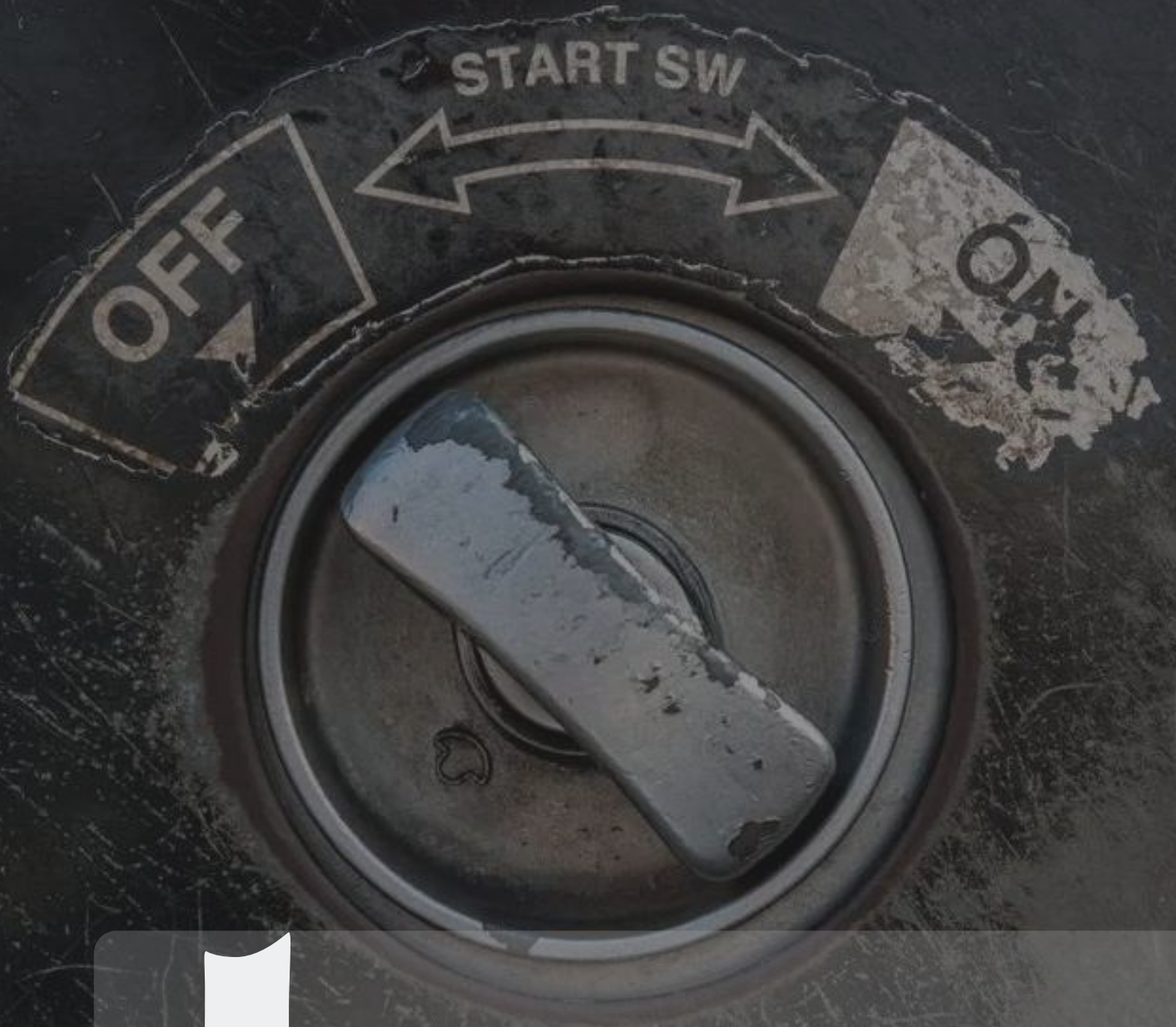

5

ÇELËSA PARKET

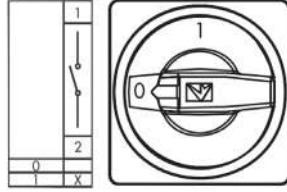

Pole	Ngarkesa	Kodi	Çmimi
1	16 A -PSK11	PSA016AK141E	
1	20 A -PSK11	PSA020AK141E	
1	25 A -PSK11	PSA025AK141E	
1	32 A -PSK21	PSA032AK141E	
1	40 A -PSK21	PSA040AK141E	
1	50 A -PSK31	PSA050AK141E	
1	63 A -PSK31	PSA063AK141E	
1	80 A	PSA080AK141E	

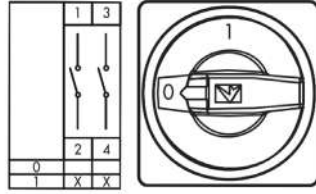

Pole	Ngarkesa	Kodi	Çmimi
2	16 A -PSK11	PSA016AK241E	
2	20 A -PSK11	PSA020AK241E	
2	25 A -PSK11	PSA025AK241E	
2	32 A -PSK21	PSA032AK241E	
2	40 A -PSK21	PSA040AK241E	
2	50 A -PSK31	PSA050AK241E	
2	63 A -PSK31	PSA063AK241E	
2	80 A	PSA080AK241E	

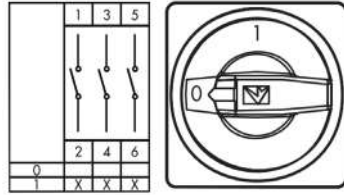

Pole	Ngarkesa	Kodi	Çmimi
3	16 A -PSK11	PSA016AK341E	
3	20 A -PSK11	PSA020AK341E	
3	25 A -PSK11	PSA025AK341E	
3	32 A -PSK21	PSA032AK341E	
3	40 A -PSK21	PSA040AK341E	
3	50 A -PSK31	PSA050AK341E	
3	63 A -PSK31	PSA063AK341E	
3	80 A	PSA080AK341E	

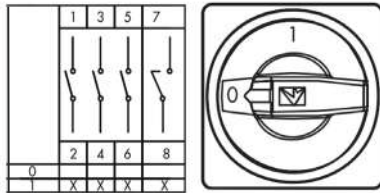

Pole	Ngarkesa	Kodi	Çmimi
3+Neutër	16 A -PSK11	PSA016AK941E	
3+Neutër	20 A -PSK11	PSA020AK941E	
3+Neutër	25 A -PSK11	PSA025AK941E	
3+Neutër	32 A -PSK21	PSA032AK941E	
3+Neutër	40 A -PSK21	PSA040AK941E	
3+Neutër	50 A -PSK31	PSA050AK941E	
3+Neutër	63 A -PSK31	PSA063AK941E	
3+Neutër	80 A	PSA080AK941E	

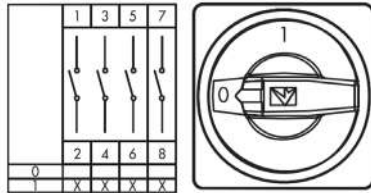

Pole	Ngarkesa	Kodi	Çmimi
4	16 A -PSK11	PSA016AK441E	
4	20 A -PSK11	PSA020AK441E	
4	25 A -PSK11	PSA025AK441E	
4	32 A -PSK21	PSA032AK441E	
4	40 A -PSK21	PSA040AK441E	
4	50 A -PSK31	PSA050AK441E	
4	63 A -PSK31	PSA063AK441E	
4	80 A	PSA080AK441E	

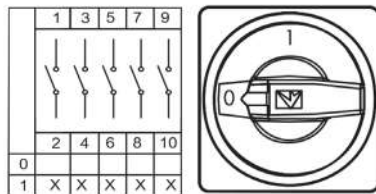

Pole	Ngarkesa	Kodi	Çmimi
5	16 A -PSK12	PSA016AK541E	
5	20 A -PSK12	PSA020AK541E	
5	25 A -PSK12	PSA025AK541E	
5	32 A -PSK22	PSA032AK541E	
5	40 A -PSK22	PSA040AK541E	
5	50 A	PSA050AK541E	
5	63 A	PSA063AK541E	
5	80 A	PSA080AK541E	

Pole	Ngarkesa	Kodi	Çmimi
1	16 A -PSK11	PSA016AK131S	
1	20 A -PSK11	PSA020AK131S	
1	25 A -PSK11	PSA025AK131S	
1	32 A -PSK21	PSA032AK131S	
1	40 A -PSK21	PSA040AK131S	
1	50 A -PSK31	PSA050AK131S	
1	63 A -PSK31	PSA063AK131S	
1	80 A	PSA080AK131S	

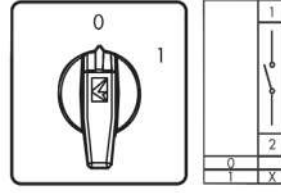

Pole	Ngarkesa	Kodi	Çmimi
2	16 A -PSK11	PSA016AK231S	
2	20 A -PSK11	PSA020AK231S	
2	25 A -PSK11	PSA025AK231S	
2	32 A -PSK21	PSA032AK231S	
2	40 A -PSK21	PSA040AK231S	
2	50 A -PSK31	PSA050AK231S	
2	63 A -PSK31	PSA063AK231S	
2	80 A	PSA080AK231S	

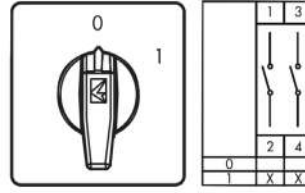

Pole	Ngarkesa	Kodi	Çmimi
3	16 A -PSK11	PSA016AK331S	
3	20 A -PSK11	PSA020AK331S	
3	25 A -PSK11	PSA025AK331S	
3	32 A -PSK21	PSA032AK331S	
3	40 A -PSK21	PSA040AK331S	
3	50 A -PSK31	PSA050AK331S	
3	63 A -PSK31	PSA063AK331S	
3	80 A	PSA080AK331S	

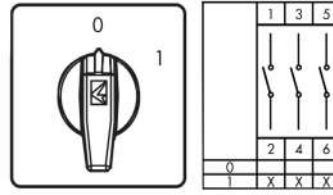

Pole	Ngarkesa	Kodi	Çmimi
3+Neutër	16 A -PSK11	PSA016AK831S	
3+Neutër	20 A -PSK11	PSA020AK831S	
3+Neutër	25 A -PSK11	PSA025AK831S	
3+Neutër	32 A -PSK21	PSA032AK831S	
3+Neutër	40 A -PSK21	PSA040AK831S	
3+Neutër	50 A -PSK31	PSA050AK831S	
3+Neutër	63 A -PSK31	PSA063AK831S	
3+Neutër	80 A	PSA080AK831S	

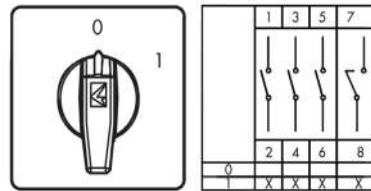

Pole	Ngarkesa	Kodi	Çmimi
4	16 A -PSK11	PSA016AK431S	
4	20 A -PSK11	PSA020AK431S	
4	25 A -PSK11	PSA025AK431S	
4	32 A -PSK21	PSA032AK431S	
4	40 A -PSK21	PSA040AK431S	
4	50 A -PSK31	PSA050AK431S	
4	63 A -PSK31	PSA063AK431S	
4	80 A	PSA080AK431S	

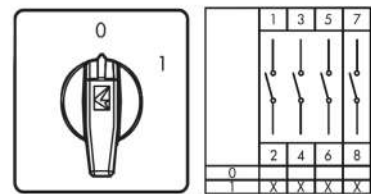

Pole	Ngarkesa	Kodi	Çmimi
5	16 A -PSK12	PSA016AK531S	
5	20 A -PSK12	PSA020AK531S	
5	25 A -PSK12	PSA025AK531S	
5	32 A -PSK22	PSA032AK531S	
5	40 A -PSK22	PSA040AK531S	
5	50 A	PSA050AK531S	
5	63 A	PSA063AK531S	
5	80 A	PSA080AK531S	

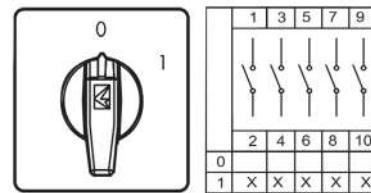

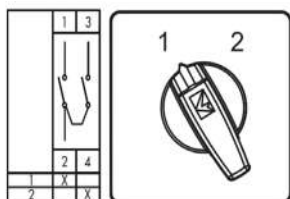

Pole	Ngarkesa	Kodi	Çmimi
1	16 A -PSK11	PSA016KD133S	
1	20 A -PSK11	PSA020KD133S	
1	25 A -PSK11	PSA025KD133S	
1	32 A -PSK21	PSA032KD133S	
1	40 A -PSK21	PSA040KD133S	
1	50 A -PSK31	PSA050KD133S	
1	63 A -PSK31	PSA063KD133S	
1	80 A	PSA080KD133S	

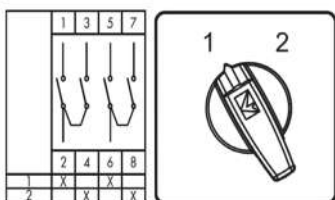

Pole	Ngarkesa	Kodi	Çmimi
2	16 A -PSK11	PSA016KD233S	
2	20 A -PSK11	PSA020KD233S	
2	25 A -PSK11	PSA025KD233S	
2	32 A -PSK31	PSA032KD233S	
2	40 A -PSK31	PSA040KD233S	
2	50 A	PSA050KD233S	
2	63 A	PSA063KD233S	
2	80 A	PSA080KD233S	

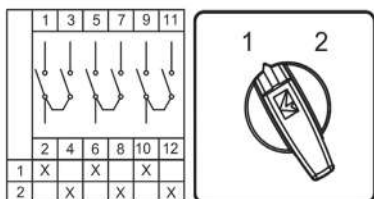

Pole	Ngarkesa	Kodi	Çmimi
3	16 A -PSK12	PSA016KD333S	
3	20 A -PSK12	PSA020KD333S	
3	25 A -PSK12	PSA025KD333S	
3	32 A -PSK31	PSA032KD333S	
3	40 A -PSK31	PSA040KD333S	
3	50 A	PSA050KD333S	
3	63 A	PSA063KD333S	
3	80 A	PSA080KD333S	

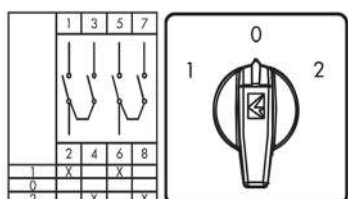

Pole	Ngarkesa	Kodi	Çmimi
2	16 A -PSK11	PSA016KD234S	
2	20 A -PSK11	PSA020KD234S	
2	25 A -PSK11	PSA025KD234S	
2	32 A -PSK21	PSA032KD234S	
2	40 A -PSK21	PSA040KD234S	
2	50 A -PSK31	PSA050KD234S	
2	63 A -PSK31	PSA063KD234S	
2	80 A	PSA080KD234S	

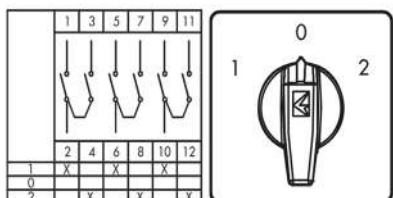

Pole	Ngarkesa	Kodi	Çmimi
3	16 A -PSK12	PSA016KD334S	
3	20 A -PSK12	PSA020KD334S	
3	25 A -PSK12	PSA025KD334S	
3	32 A -PSK22	PSA032KD334S	
3	40 A -PSK22	PSA040KD334S	
3	50 A	PSA050KD334S	
3	63 A	PSA063KD334S	
3	80 A	PSA080KD334S	

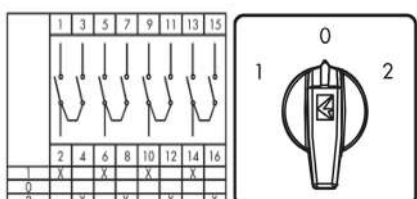

Pole	Ngarkesa	Kodi	Çmimi
4	16 A -PSK12	PSA016KD434S	
4	20 A -PSK12	PSA020KD434S	
4	25 A -PSK12	PSA025KD434S	
4	32 A -PSK22	PSA032KD434S	
4	40 A -PSK22	PSA040KD434S	
4	50 A	PSA050KD434S	
4	63 A	PSA063KD434S	
4	80 A	PSA080KD434S	

Pole	Ngarkesa	Kodi	Çmimi
0-1-2	16 A -PSK11	PSA016KS132S	
0-1-2	20 A -PSK11	PSA020KS132S	
0-1-2	25 A -PSK11	PSA025KS132S	
0-1-2	32 A -PSK21	PSA032KS132S	
0-1-2	40 A -PSK21	PSA040KS132S	
0-1-2	50 A -PSK31	PSA050KS132S	
0-1-2	63 A -PSK31	PSA063KS132S	
0-1-2	80 A	PSA080KS132S	

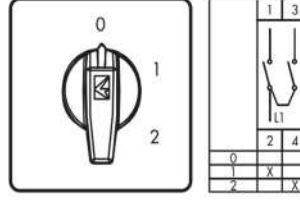

Pole	Ngarkesa	Kodi	Çmimi
0-3	16 A -PSK11	PSA016KS133S	
0-3	20 A -PSK11	PSA020KS133S	
0-3	25 A -PSK11	PSA025KS133S	
0-3	32 A -PSK21	PSA032KS133S	
0-3	40 A -PSK21	PSA040KS133S	
0-3	50 A -PSK31	PSA040KS133S	
0-3	63 A -PSK32	PSA063KS133S	
0-3	80 A	PSA080KS133S	

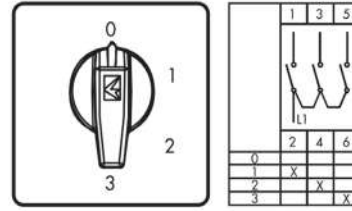

Pole	Ngarkesa	Kodi	Çmimi
0-4	16 A -PSK12	PSA016KS134S	
0-4	20 A -PSK12	PSA020KS134S	
0-4	25 A -PSK12	PSA025KS134S	
0-4	32 A -PSK22	PSA032KS134S	
0-4	40 A -PSK22	PSA040KS134S	
0-4	50 A -PSK32	PSA050KS134S	
0-4	63 A -PSK32	PSA063KS134S	
0-4	80 A	PSA080KS134S	

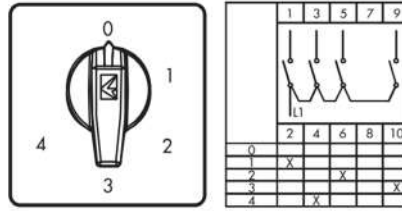

Pole	Ngarkesa	Kodi	Çmimi
0-5	16 A -PSK12	PSA016KS135S	
0-5	20 A -PSK12	PSA020KS135S	
0-5	25 A -PSK12	PSA025KS135S	
0-5	32 A -PSK22	PSA032KS135S	
0-5	40 A -PSK22	PSA040KS135S	
0-5	50 A	PSA063KS135S	
0-5	63 A	PSA080KS135S	
0-5	80 A	PSA080KS135S	

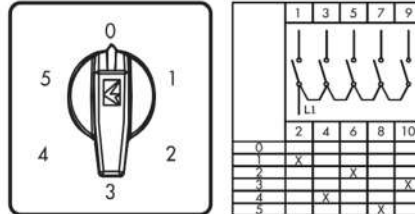

Pole	Ngarkesa	Kodi	Çmimi
0-6	16 A -PSK12	PSA016KS126S	
0-6	20 A -PSK12	PSA020KS126S	
0-6	25 A -PSK12	PSA025KS126S	
0-6	32 A -PSK22	PSA032KS126S	
0-6	40 A -PSK22	PSA040KS126S	
0-6	50 A	PSA050KS126S	
0-6	63 A	PSA063KS126S	
0-6	80 A	PSA080KS126S	

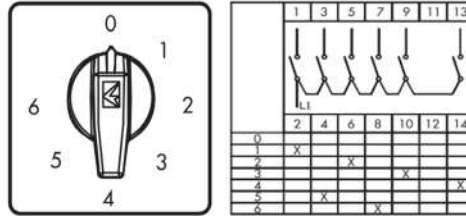

Pole	Ngarkesa	Kodi	Çmimi
0-7	16 A -PSK12	PSA016KS127S	
0-7	20 A -PSK12	PSA020KS127S	
0-7	25 A -PSK12	PSA025KS127S	
0-7	32 A -PSK22	PSA032KS127S	
0-7	40 A -PSK22	PSA040KS127S	
0-7	50 A	PSA063KS127S	
0-7	63 A	PSA080KS127S	
0-7	80 A	PSA080KS134S	

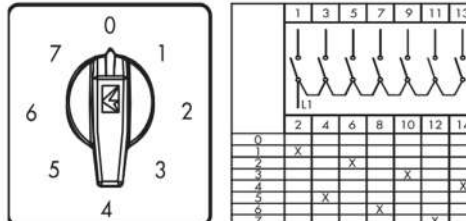

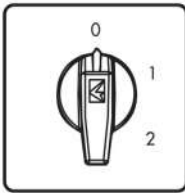
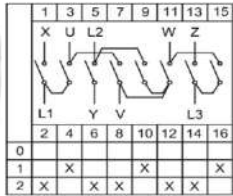
Çelës trefazor për dy shpejtësi 0-1-2

Pole	Ngarkesa	Kodi	Çmimi
3 fazore	16 A -PSK12	PSA016CD332S	
	20 A -PSK12	PSA020CD332S	
	25A -PSK12	PSA025CD332S	
	32A-PSK22	PSA032CD332S	
	40A-PSK22	PSA040CD332S	
	50A	PSA050CD332S	
	63A	PSA063CD332S	
	80A	PSA080CD332S	

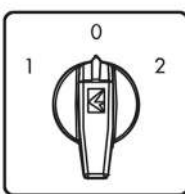
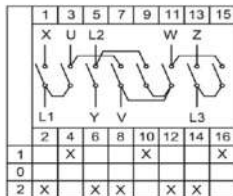
Çelës trefazor për dy shpejtësi 1-0-2

Pole	Ngarkesa	Kodi	Çmimi
3 fazore	16 A -PSK12	PSA016CD334S	
	20 A -PSK12	PSA020CD334S	
	25A -PSK12	PSA025CD334S	
	32A-PSK22	PSA032CD334S	
	40A-PSK22	PSA040CD334S	
	50A	PSA050CD334S	
	63A	PSA063CD334S	
	80A	PSA080CD334S	

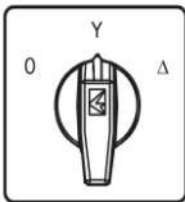
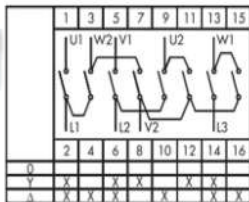
Çelës trefazor yll-trekëndësh

Pole	Ngarkesa	Kodi	Çmimi
3-fazorë	16 A -PSK12	PSA016MS335S	
	20 A -PSK12	PSA020MS335S	
	25 A -PSK12	PSA025MS335S	
	32 A -PSK22	PSA032MS335S	
	40 A -PSK22	PSA040MS335S	
	50 A	PSA050MS335S	
	63 A	PSA063MS335S	
	80 A	PSA080MS335S	

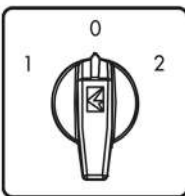
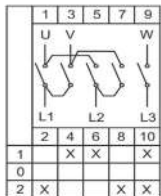
Çelës trefazor ndërrim sensi majtas-djathtas 1-0-2

Pole	Ngarkesa	Kodi	Çmimi
3 fazore	16 A -PSK12	PSA016MS334S	
	20 A -PSK12	PSA020MS334S	
	25A -PSK12	PSA025MS334S	
	32A-PSK22	PSA032MS334S	
	40A-PSK22	PSA040MS334S	
	50A-PSK32	PSA050MS334S	
	63A-PSK32	PSA063MS334S	
	80A	PSA080MS334S	

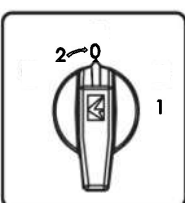
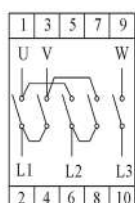
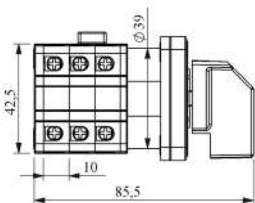
Çelës trefazor ndërrim sensi majtas-djathtas (2)-0-1 pozicioni 2 me rikthim

Pole	Ngarkesa	Kodi	Çmimi
3-fazorë	16 A -PSK12	PSA016MS336S	
	20 A -PSK12	PSA020MS336S	
	25 A -PSK12	PSA025MS336S	
	32 A -PSK22	PSA032MS336S	
	40 A -PSK22	PSA040MS336S	
	50 A	PSA050MS336S	
	63 A	PSA063MS336S	
	80 A	PSA080MS336S	

Pole	Ngarkesa	Kodi	Çmimi	Voltmeter	Diagram	Image
3 fazore	10 A -PSK11	PSA010OK421S				
	16 A -PSK11	PSA016OK421S				
	20 A -PSK11	PSA020OK421S				
3 fazore	10 A -PSK11	PSA010OK422S				
	16 A -PSK11	PSA016OK422S				
	20 A -PSK11	PSA020OK422S				
3 fazore	10 A -PSK12	PSA010OK426S				
	16 A -PSK12	PSA016OK426S				
	20 A -PSK12	PSA020OK426S				
3 fazore	10 A -PSK12	PSA010OK723S				
	16 A -PSK12	PSA016OK723S				
	20 A -PSK12	PSA020OK723S				

Kodi	Dimensionet	Mbrojtja	Çmim	Kodi	Dimensionet	Mbrojtja	Çmim
PSK11	75x85x65 (mm)	IP54		PSK11E	75x85x65 (mm)	IP65	
PSK21	75x85x90 (mm)	IP54		PSK21E	75x85x90 (mm)	IP65	
PSK31	91x100x73 (mm)	IP54		PSK31E	91x100x73 (mm)	IP65	
PSK12	91x100x103 (mm)	IP54		PSK12E	91x100x103 (mm)	IP65	
PSK22	106x116x86 (mm)	IP54		PSK22E	106x116x86 (mm)	IP65	
PSK32	106x116x128 (mm)	IP54		PSK32E	106x116x128 (mm)	IP65	



PSK11



PSK12



PSK21



PSK22



PSK31



PSK32



Pole	Ngarkesa	Kodi	Çmimi
1P	16A	YCBZ-401P16	
	25A	YCBZ-401P25	
	32A	YCBZ-401P32	
	40A	YCBZ-401P40	

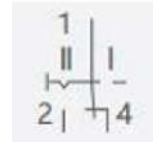

Pole	Ngarkesa	Kodi	Çmimi
2P	16A	YCBZ-402P16	
	25A	YCBZ-402P25	
	32A	YCBZ-402P32	
	40A	YCBZ-402P40	

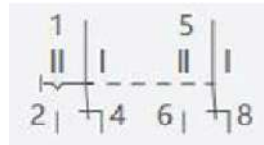

Pole	Ngarkesa	Kodi	Çmimi
3P	16A	YCBZ-403P16	
	25A	YCBZ-403P25	
	32A	YCBZ-403P32	
	40A	YCBZ-403P40	

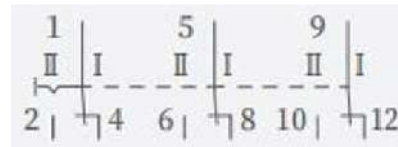

Pole	Ngarkesa	Kodi	Çmimi
4P	16A	YCBZ-404P16	
	25A	YCBZ-404P25	
	32A	YCBZ-404P32	
	40A	YCBZ-404P40	

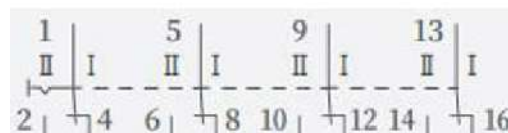

Pole	Ngarkesa	Kodi	Çmimi
4 P	63A	YCBZ125/4063	
	80A	YCBZ125/4080	
	100A	YCBZ125/4100	

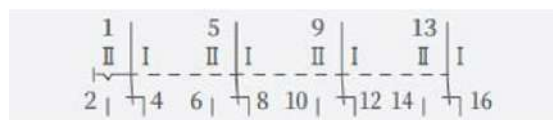

6

ÇELËSA FUNDORË &
SENSORË

GWEST

Mikroçelësa fundorë të serisë SS



KODI	SS0500A
ÇMIMI	
PERMASAT	20x10mm
FUQIA	3A-250VAC



KODI	SS0503A
ÇMIMI	
PERMASAT	20x10mm
FUQIA	3A-250VAC



KODI	SS0505A
ÇMIMI	
PERMASAT	20x10mm
FUQIA	3A-250VAC

GWEST

Miniçelësa fundorë të serisë GMS



KODI	GMS100
ÇMIMI	
PERMASAT	27.5x15.8mm
FUQIA	10A-250VAC



KODI	GMS101
ÇMIMI	
PERMASAT	27.5x15.8mm
FUQIA	10A-250VAC



KODI	GMS102
ÇMIMI	
PERMASAT	27.5x15.8mm
FUQIA	10A-250VAC



KODI	GMS103
ÇMIMI	
PERMASAT	27.5x15.8mm
FUQIA	10A-250VAC



KODI	GMS104
ÇMIMI	
PERMASAT	27.5x15.8mm
FUQIA	10A-250VAC



KODI	GMS105
ÇMIMI	
PERMASAT	27.5x15.8mm
FUQIA	10A-250VAC



KODI	MK1MIP3
ÇMIMI	
PERMASAT	27.5x15.8mm
FUQIA	10A-250VAC



KODI	GMS106
ÇMIMI	
PERMASAT	27.5x15.8mm
FUQIA	10A-250VAC



KODI	MK1PUM9
ÇMIMI	
PERMASAT	27.5x15.8mm
FUQIA	6A (250V AC)



KODI AZ15GB
ÇMIMI



KODI AZ15GDB
ÇMIMI



KODI AZ15GSB
ÇMIMI



KODI AZ15GW21B
ÇMIMI



KODI AZ15HW24B
ÇMIMI



KODI AZ15GWB
ÇMIMI



KODI AZ15GW2B
ÇMIMI



KODI AZ15GW22B
ÇMIMI



KODI AZ15GW2277B
ÇMIMI



KODI AZ15GQB
ÇMIMI



KODI AZ15GQ22B
ÇMIMI



KODI AZ15GQ21B
ÇMIMI

GWEST

Çelësa fundorë 65x30mm (6A-250VAC)

 Kodi GLS103
 Çmim

 Kodi GLS103R
 Çmim

 Kodi GLS111
 Çmim

 Kodi GLS127
 Çmim

 Kodi GLS161
 Çmim

 Kodi GLS171
 Çmim

 Kodi GLS101
 Çmim

 Kodi GLS121
 Çmim

 Kodi GLS131
 Çmim

 Kodi GLS191
 Çmim



Kodi L51K23HUM111
Çmim



Kodi L5K23BEM621
Çmim

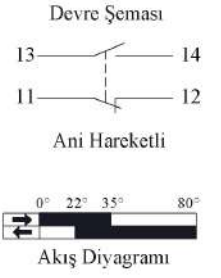
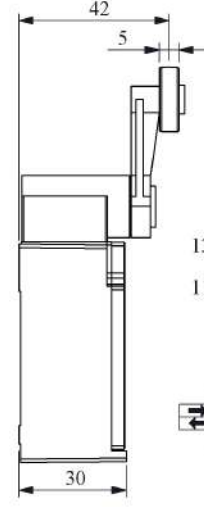
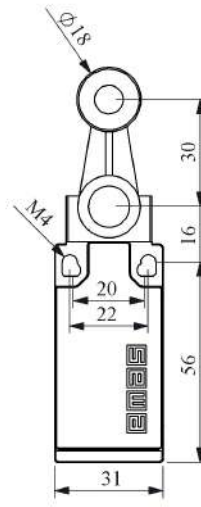

Kodi L5K23LUM321
Çmim



Kodi L5K23LUM322
Çmim



Kodi L5K23LUM323
Çmim



Kodi L5K23LUM324
Çmim



Kodi L5K13CPDE
Çmim



Kodi L5K23LEM411
Çmim



Kodi L5K23LEM511
Çmim



Kodi L5K23LEM622
Çmim

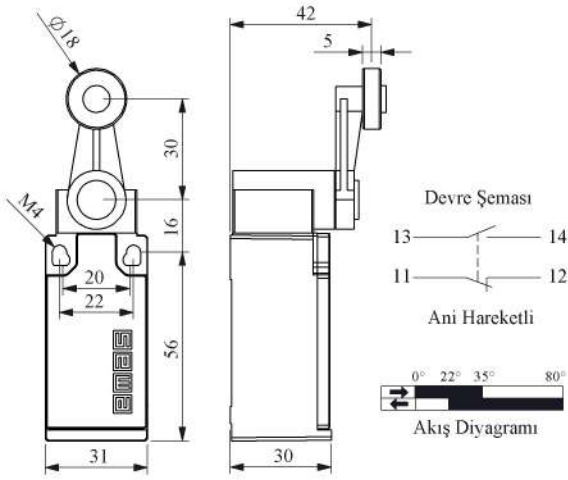

Kodi L5K13MIP311R

Çmim



Kodi L5K13MIP411R

Çmim



Kodi L5K13REM121

Çmim



Kodi L5K13ROP101

Çmim



Kodi L5K13MEP124

Çmim



Kodi L5K13MEP122R

Çmim



Kodi L5K13MIM211

Çmim



Kodi L5K13MEL121

Çmim



Kodi L5K13MEL123A

Çmim



Kodi L5K13MEL123R

Çmim

Çelësa fundorë Seria L51/ 65x30mm (6A-250VAC)



Kodi L51K13MUM331
Çmim



Kodi L51K13PUM211
Çmim

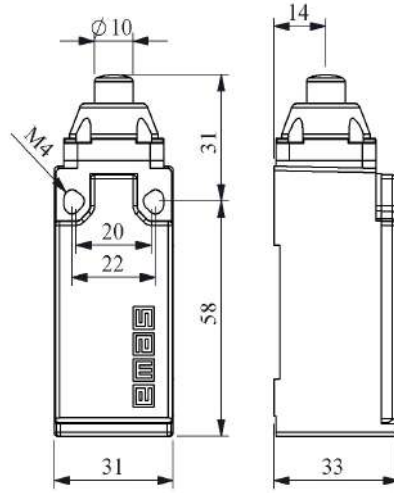

Kodi L51K13MIM311
Çmim



Kodi L51K13MIM411
Çmim



Kodi L51K13REM121
Çmim



Kodi L51K13SOM101
Çmim



Kodi L51K13MEM121
Çmim



Kodi L51K13MEM122
Çmim



Kodi L51K13MEM123
Çmim



Kodi L51K13MEM124
Çmim



Kodi L52K13SOP101
Çmim



Kodi L52K13SOM101
Çmim



Kodi L52K13MUM331
Çmim



Kodi L52K13PUM211
Çmim



Kodi L52K13MIM311
Çmim



Kodi L52K13MIM411
Çmim



Kodi L52K13MEM121
Çmim



Kodi L52K13MEM122
Çmim



Kodi L52K13MEM123
Çmim



Kodi L52K13MEM124
Çmim

Çelësa fundorë Seria L52/ 75x40mm (3A-250VAC)



Kodi L52K13REF121
Çmim



Kodi L52K13REM121
Çmim

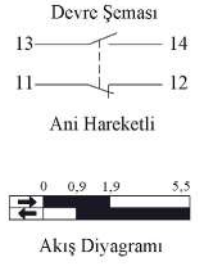
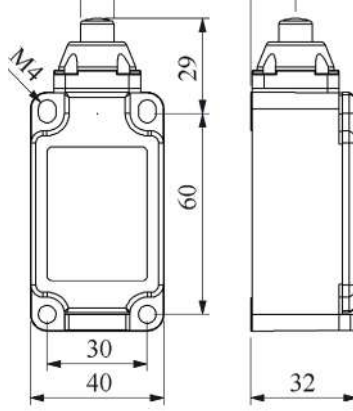

Kodi L52K13MEP125
Çmim



Kodi L52K13MIM211
Çmim



Kodi L52K13ROP101
Çmim



Kodi L52K13SOM103
Çmim



Kodi L52K13MEL121
Çmim



Kodi L52K13MEL122
Çmim



Kodi L52K13MEL123
Çmim



Kodi L52K13MEL123A
Çmim

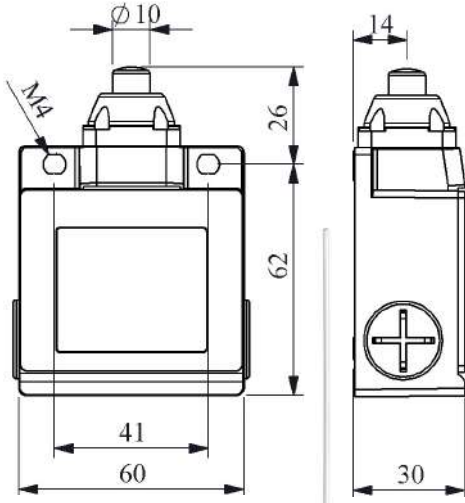

Kodi L53K13MUM331
Çmim



Kodi L53K13PUM211
Çmim



Kodi L53K13SOP101
Çmim



Kodi L53K13SOM101
Çmim



Kodi L53K13MIM311
Çmim



Kodi L53K13MIM411
Çmim



Kodi L53K13MEM121
Çmim



Kodi L53K13MEM122
Çmim



Kodi L53K13MEM123
Çmim



Kodi L53K13MEM124
Çmim

Çelësa fundorë Seria L53/ 67x60mm (3A-250VAC)



Kodi L53K23HUM112
Çmim



Kodi L53K13REM121
Çmim

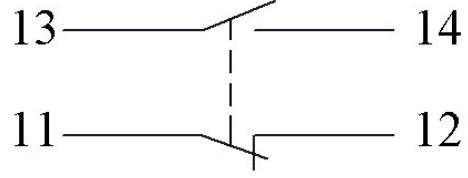

Kodi L53K13MEP125
Çmim



Kodi L53K13MIM211
Çmim



Kodi L53K13ROP101
Çmim



Kodi L53K13SOM103
Çmim



Kodi L53K13MEL121
Çmim



Kodi L53K13MEL122
Çmim



Kodi L53K13MEL123
Çmim



Kodi L53K13MEL123A
Çmim



Kodi L61K13PUM211
Çmim



Kodi L61K13MUM331
Çmim



Kodi L61K13MIM311
Çmim



Kodi L61K13MEM121
Çmim



Kodi L61K13MEP121
Çmim



Kodi L61K13MIP311
Çmim



Kodi MN3PUM9
Çmim



Kodi MN3KIM1
Çmim



Kodi MN3KIM2
Çmim



Kodi MN3MUM3
Çmim



Kodi MN3MIM1
Çmim



Kodi MN3MIM2
Çmim

Kontakte për çelësa fundorë te serive I5,I51,I52,I53,I54



LK20K12



LK20K13



LK20K25



LK20K27

Kodi	Veprimi	Kontakti	Seria Çelësit	Çmimi
LK20K12	I shpejte	2NC	L5,L51,K52,L53,L54	
LK20K13	I shpejte	1NO+NC	L5,L51,K52,L53,L54	
LK20K25	I ngadalte	2NC+1NO	L5,L51,K52,L53,L54	
LK20K27	I ngadalte	2NO+1NC	L5,L51,K52,L53,L54	
LK20K22	I ngadalte	2NC	L5,L51,K52,L53,L54	
LK20K23	I ngadalte	1NO+NC	L5,L51,K52,L53,L54	

Seri të tjera çelësash fundorë

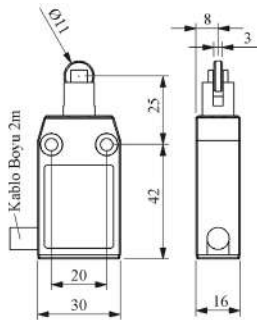

Seria L66

SK5P
3A-250V AC
2880L

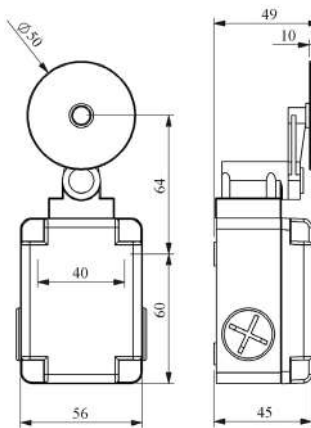

Seria L1

Seria L4

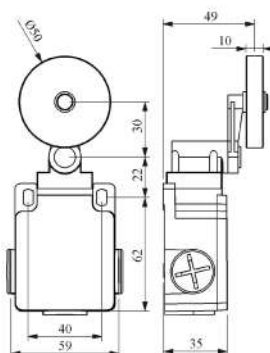
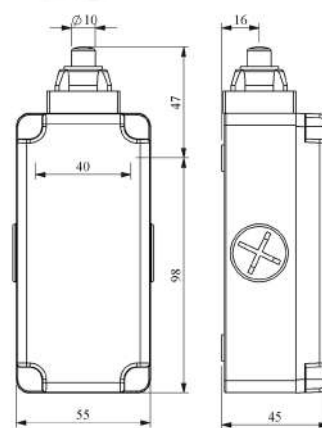

Seria L2

Seria L54

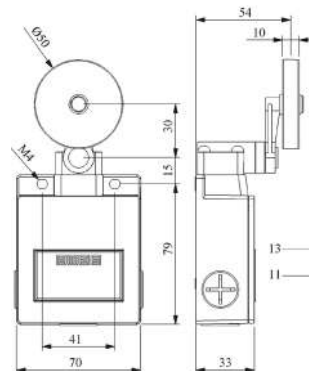

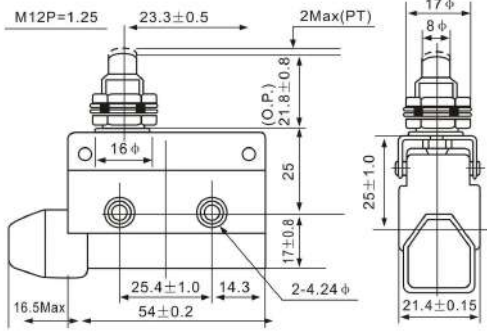

Kodi AZ-7100
Çmim



Kodi AZ-7110
Çmim



Kodi AZ-7120
Çmim



Kodi AZ-7121
Çmim



Kodi AZ-7124
Çmim



Kodi AZ-7140
Çmim



Kodi AZ-7141
Çmim



Kodi AZ-7144
Çmim



Kodi AZ-7310
Çmim



Kodi AZ-7311
Çmim



Kodi AZ-7312
Çmim

Sensorë induktive 10-30VDC me cilindër ø12mm



SIM12FM1NC2



SIM12FM1PSX



SIM12NM1NC2



SIM12NM1PC2



	10-30VDC ø12mm	Monitmi	Frekuenca	Lidhja	Output	Kodi	Çmimi
Distanca e ndjeshmërisë	2mm	i brendshem	800Hz	Kabëll (2m)	NPN-NO	SIM12FM1NC2	
				Bashkues M12	NPN-NO	SIM12FM1NSX	
				Kabëll (2m)	NPN-NC	SIM12FM1OC2	
				Bashkues M12	NPN-NC	SIM12FM1OSX	
				Kabëll (2m)	NPN-NO	SIM12FM1PC2	
				Bashkues M12	NPN-NO	SIM12FM1PSX	
	4mm	i jashtëm	400Hz	Kabëll (2m)	NPN-NC	SIM12FM1RC2	
				Bashkues M12	NPN-NC	SIM12FM1RSX	
				Kabëll (2m)	NPN-NO	SIM12NM1NC2	
				Bashkues M12	NPN-NO	SIM12NM1NSX	
				Kabëll (2m)	NPN-NC	SIM12NM1OC2	
				Bashkues M12	NPN-NC	SIM12NM1OSX	
				Kabëll (2m)	NPN-NO	SIM12NM1PC2	
				Bashkues M12	NPN-NO	SIM12NM1PSX	
				Kabëll (2m)	NPN-NC	SIM12NM1RC2	
				Bashkues M12	NPN-NC	SIM12NM1RSX	

Sensorë induktive 10-30VDC me cilindër ø18mm



SIM18FM1NC2



SIM12FM1PC2



SIM12NM1NC2



SIM12NM1PC2



	10-30VDC ø18mm	Monitmi	Frekuenca	Lidhja	Output	Kodi	Çmimi
Distanca e ndjeshmërisë	5mm	i brendshem	800Hz	Kabëll (2m)	NPN-NO	SIM18FM1NC2	
					NPN-NC	SIM18FM1OC2	
					NPN-NO	SIM18FM1PC2	
					NPN-NC	SIM18FM1RC2	
					NPN-NO	SIM18NM1NC2	
	8mm	i jashtëm	400Hz		NPN-NC	SIM18NM1OC2	
					NPN-NO	SIM18NM1PC2	
					NPN-NO	SIM18NM1PSX	
					NPN-NC	SIM18NM1RC2	
					NPN-NC	SIM18NM1RSX	

Sensorë induktive 10-30VDC me cilindër ø30mm



SIM30FM1NC2



SIM30FM1NSX



SIM30NM1NC2



SIM30NM1PC2



	10-30VDC ø30mm	Monitmi	Frekuenca	Lidhja	Output	Kodi	Çmimi	
Distanca e ndjeshmërisë	10mm	i brendshem	400Hz	Kabëll (2m)	NPN-NO	SIM30FM1NC2		
					Bashkues M12	NPN-NO	SIM30FM1NSX	
					NPN-NC	SIM30FM1OC2		
					Bashkues M12	NPN-NC	SIM30FM1OSX	
					NPN-NO	SIM30FM1PC2		
					Bashkues M12	NPN-NO	SIM30FM1PSX	
					NPN-NC	SIM30FM1RC2		
					Bashkues M12	NPN-NC	SIM30FM1RSX	
	15mm	i jashtëm	200Hz		NPN-NO	SIM30NM1NC2		
					Bashkues M12	NPN-NO	SIM30NM1NSX	
					NPN-NC	SIM30NM1OC2		
					Bashkues M12	NPN-NC	SIM30NM1OSX	
					NPN-NO	SIM30NM1PC2		
					Bashkues M12	NPN-NO	SIM30NM1PSX	
					NPN-NC	SIM30NM1RC2		
					Bashkues M12	NPN-NC	SIM30NM1RSX	

emas

Sensorë kapacitivë



SCM18NP1NC2



SCM30NP1NC2



SCM30NP1NSX



SCM30NM1RSX

	Lloji	Montimi	Frekuenca	Lidhja	Output	Kodi	Çmimi
Distanc	2-10mm	Cilindër ø18mm	I jashtëm	plastik	Kabëll (2m)	NPN-NO	SCM18NP1NC2
				plastik	Kabëll (2m)	NPN-NC	SCM18NP1OC2
				plastik	Kabëll (2m)	NPN-NO	SCM18NP1PC2
				plastik	Kabëll (2m)	NPN-NC	SCM18NP1RC2

emas

Sensorë fotoelektrik

SPM18DP4DC2



SPQ50RP2CC2



	Lloji	Voltazhi	Koha operimit	Lidhja	Output	Kodi	Çmimi
Distanca e ndjeshmërisë	400 mm	Cilindër ø30mm	10-30VDC	2ms	Kabëll (2m)	PNP 1NO+1NC	SPM18DP4DC2
					Kabëll (2m)	PNP 1NO+1NC	SPM18DP4EC2
	7 Meter	Katrë 50 gradë	24-240VAC/DC	max 20ms	Kabëll (2m)	Rele	SPQ50RP2CC2
					Bashkues M12	Rele	SPQ50RP2CSX

emas

Sensorë Induktivë

10-30VDC



	Katrë 18 gradë	Montimi	Frekuenca	Lidhja	Output	Kodi	Çmimi
Ndejsh-meria	8mm	i jashtëm	400Hz	Kabell 2 metra	NPN-NO	SIQ18NP1NC2	
					NPN-NC	SIQ18NP1OC2	
					NPN-NO	SIQ18NP1PC2	
					NPN-NC	SIQ18NP1RC2	

emas

Konektorë për sensorë



Kodi	Hyrja	Kabulli	Izolimi	Çmimi
SKM12P4YXV2	I shprejte	PVC 2 metra	IP65	
SKM12P4DXV2	Kendore	PVC 2 metra	IP65	



Kodi	Çmimi
Testues Sensori	

7

RELE ANALOGHE & DIGITALE

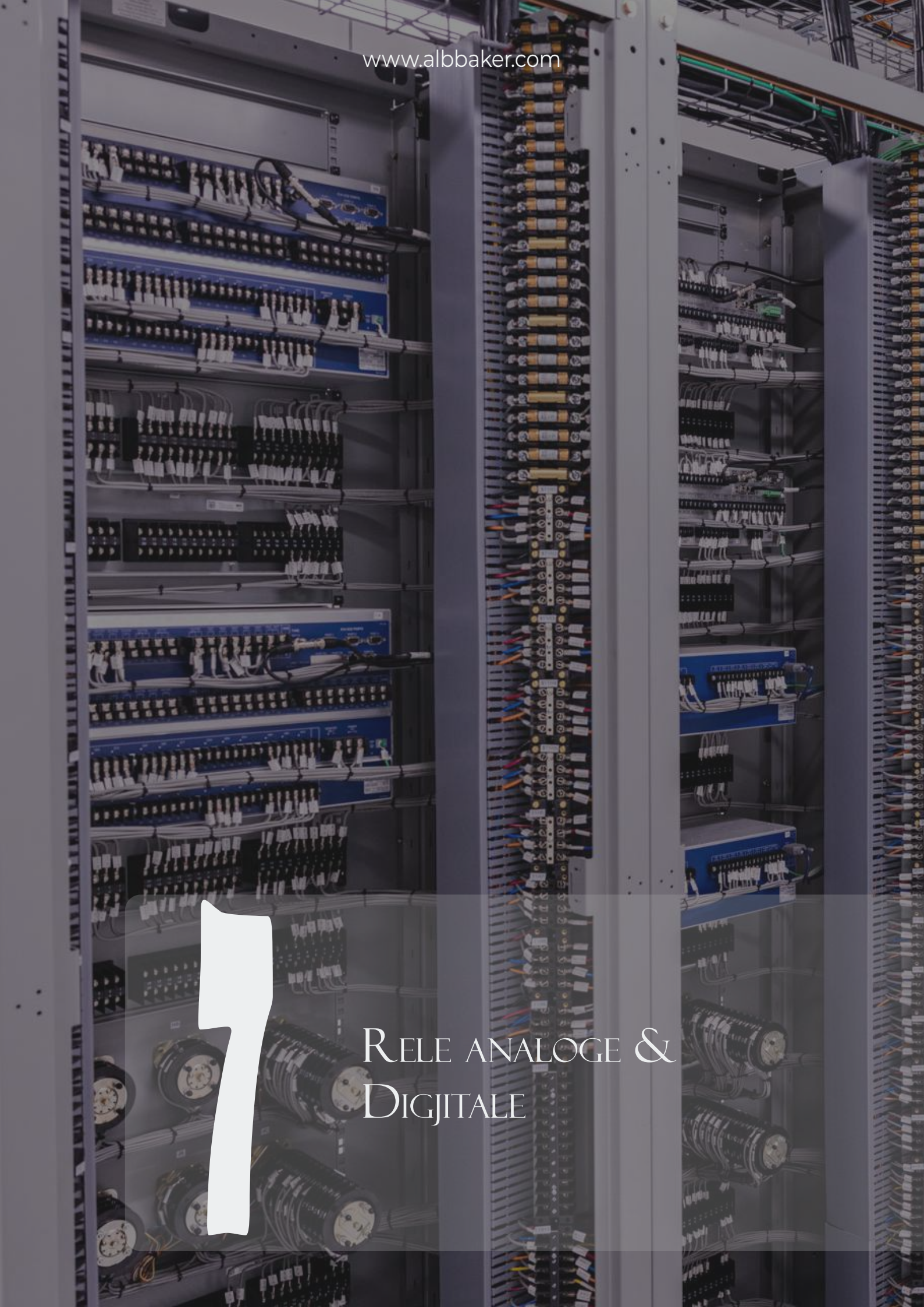



Tensioni i Operimit	Koha	Rele kohe				Output	Kodi	Çmimi
		Funksione						
		F1	F2	F3	F4			
24V AC/DC 220V AC/DC	0.06sek-30ore	√	√	√	√	10A 250V AC	RR3ZTC01	
	0.6sek-10ore			√	√		RR3ZTC02	
	0.1-30sek	√					RR3ZTS30	
	0.1-60sek	√					RR3ZTS60	



Tensioni i Operimit	Koha	Rele voltazhi					Çmimi
		Mbrjtja	Output	Faza	Kodi		
220V AC 380V AC	0.1-20sek	230-300V AC	15-210V AC	1 fazor	RR3VP01		
	0.1-20sek	230-300V AC	15-210V AC	3 fazor	RR3VP02		
	0.1-10sek	+5-30%	-5-30%	3 fazor	RR3VP02N		



Tensioni i Operimit	= TENSIONIT	Rele për mbrojtje motorri			Output	Kodi	Çmimi
		Humbje faze	Mbrojtje termike				
220V AC	20%	√			10A 250V AC	RR3MP1N	
	40%	√				RR3MP2N	
	40%	√				RR3MP2F	
	40%	√	√			RR3MP2FP	
	5-15%	√		√		RR3MP4F	
	5-15%	√		√		RR3MP4FP	



Tensioni i Operimit	Koha	Rele yll trekendesh				Çmimi
		Funks	Output	Kodi		
220V AC	Yll(3-30sek) Yll-Δ(50-500min)	Yll-Δ	2NO 10A/250V AC	RR3YU01		
	Yll(3-30sek) Yll-Δ(50-500min)	Yll-Δdhe	2NO 10A/250V AC	RR3YU01		
	=sensi (0.6s-5min)	=sensi				



Tensioni i Operimit	Fluksi i dritës	Rele drite dhe ndricimi				Çmimi
		Koha e voneës	Output	Kodi		
220V AC	1-10 LUX	25-40s	10A/250V AC	RR3FR01		
	Sensor Drite			RR3FRG0Z		



Tensioni i Operimit	Elektroda	Rele kontrolli per nivelin e lengjeve					Çmimi
		Ndjeshmëri	Output	DIM	Kodi		
220V AC	Ne 3 faqe Elektrode	2-50k	10A/250V AC	Ω19mm	RR3LL01		
					RR3LLPROP		

Rele kohe elektronike 36x36mm

Funks	Koha	Kodi	Çmimi	Kodi	Çmimi
Ndezës	0.3-3 sek/min	RZ1A1A03*-1	2800	RZ1A1A03*-25	
	0.6-6 sek/min	RZ1A1A06*-1	2800	RZ1A1A06*-25	
	1.2-12 sek/min	RZ1A1A12*-1	2800	RZ1A1A12*-25	
	3-30 sek/min	RZ1A1A30*-1	2800	RZ1A1A30*-25	
	6-60 sek/min	RZ1A1A60*-1	2800	RZ1A1A60*-25	
Fikes	0.3-3 sek/min	RZ1A1B03*-1	2800	RZ1A1B03*-25	
	0.6-6 sek/min	RZ1A1B06*-1	2800	RZ1A1B06*-25	
	1.2-12 sek/min	RZ1A1B12*-1	2800	RZ1A1B12*-25	
	3-30 sek/min	RZ1A1B30*-1	2800	RZ1A1B30*-25	
	6-60 sek/min	RZ1A1B60*-1	2800	RZ1A1B60*-25	



Funks	Koha	Dopio rele Tensioni i Operimit	Kodi	Çmimi
Ndezës	0.3-3sek/m	12V AC/DC	RZ1A2C03-1	
	0.6-6sek/m		RZ1A2C06-1	
	1.2-12sek/m		RZ1A2C12-1	
	3-30sek/m		RZ1A2C30-1	
	6-60sek/m		RZ1A2C60S-1	
/ Fikes	0.3-3sek/m	24V AC/DC	RZ1A2C03-2	
	0.6-6sek/m		RZ1A2C06-2	
	1.2-12sek/m		RZ1A2C12-2	
	3-30sek/m		RZ1A2C30-2	
	6-60sek/m		RZ1A2C60S-2	
	0.3-3sek/m	220V AC/DC	RZ1A2C03-5	
	0.6-6sek/m		RZ1A2C06-5	
	1.2-12sek/m		RZ1A2C12-5	
	3-30sek/m		RZ1A2C30-5	
	6-60sek/m		RZ1A2C60S-5	



Tensioni i Operimit	Humbje faze	Fazë jo e rregullt	Kodi	Çmimi
3X380V AC	√	√	RAM1S	

Rele kohe elektronike analoge Ø22mm

Funks	Koha	Tensioni i Operimit	Kontakti	Kodi	Çmimi
Ndezës	0.5-30min	10-30V DC	PNP	RZ3A1A30M2	
	1-60min		PNP	RZ3A1A60M2	
	0.1-30sek		PNP	RZ3A1A30S2	
	0.1-60sek		PNP	RZ3A1A60S2	

Suport për rele

Ngjyra	Numri	Kodi	Çmimi
GRI	8 P	RS1P08G1	
GRI	11 P	RS1P11G1	
E ZEZE	8P	RS1P08H1	
E ZEZE	11 P	RS1P11H1	
BLU	8P	RS1P08M1	
BLU	11P	RS1P11M1	





		Rele, seria SSR 24-320V			
Kontrolli i tensionit	Faza	Tensioni i ngarkesës	Rryma e ngarkesës	Kodi	Çmimi
4-32V DC	1 fazor	24-320V AC	12A	SSRP1DA012	
	1 fazor	24-320V AC	25A	SSRP1DA025	
	1 fazor	24-320V AC	40A	SSRP1DA040	



		Rele, seria SSR 50-480V			
Kontrolli i tensionit	Faza	Tensioni i ngarkesës	Rryma e ngarkesës	Kodi	Çmimi
4-32V DC	1 fazor	50-480V AC	12A	SSRP1DB012	
	1 fazor	50-480V AC	25A	SSRP1DB025	
	1 fazor	50-480V AC	40A	SSRP1DB040	



		Rele, seria SSR 50-480V			
Kontrolli i tensionit	Faza	Tensioni i ngarkesës	Rryma e ngarkesës	Kodi	Çmimi
4-32V DC	1 fazor	50-640V AC	50A	SSRP1DC050	
	1 fazor	50-640V AC	70A	SSRP1DC070	
	1 fazor	50-640V AC	100A	SSRP1DC100	
	1 fazor	50-640V AC	120A	SSRP1DC120	



		Rele, seria SSR 50-480V			
Kontrolli i tensionit	Faza	Tensioni i ngarkesës	Rryma e ngarkesës	Kodi	Çmimi
8-30V AC/DC	1 fazor	24-320V AC	12A	SSRR1EA012	
	1 fazor	24-320V AC	25A	SSRR1EA025	
	1 fazor	50-480V AC	12A	SSRR1EB012	
	1 fazor	50-480V AC	24A	SSRR1EB025	



Ftohës për rele, seria SSS				
Përmasat	Lloji	Rryma e ngarkesës	Kodi	Çmimi
45 mm X 75 mm	FTOHES AL	12A	SSSIX	
	FTOHES AL	25A	SSS2X	
45 mm X 100 mm	FTOHES +HELIK	40A	SSS2F	
	FTOHES AL	40A	SSS4X	
100 mm x75 mm	FTOHES +HELIK	50A	SSS4F	
	FTOHES AL	50A	SSS5X	
100 mm x 100 mm	FTOHES +HELIK	70-120A	SSS5F	

Termostat paneli mekanik 0-70 grade



PTM110



PTM122

Kontakti	KODI	CMIMI
1NC	PTM110	
1NO	PTM111	
1NO+1NC	PTM122	
1NC	PTE110	
1NO	PTE111	
1CO	PHTE124	

Termostat paneli 0-70 grade



PTE111



PHTE124

Panelmetër digjital

Tensioni i Operimit	Counter Entry	Lloji	Kodi	Çmimi
220/230V AC	0-5A	Ampermeter	RDA1A	
	0-600V AC	Voltmeter	RDV1A	
	100-200V AC/ 30-70Hz	Frekuence meter	RDH1A	

Numrator digjital

Tensioni i Operimit	Counter entry	Reset entry	Kodi	Çmimi
24V AC/DC	12-30V DC	12-30V DC	RZ1D1C-2	
220V AC	12-30V DC	12-30V DC	RZ1D1C-5	

Rele kohe digjitale

Tensioni i Operimit	Koha	Funksione										Kodi	Çmimi	
		A	B	F1	F2	S1	S2	S3	S4	I	P			R
24V AC/DC		√	√	√	√	√	√	√	√	√	√	√	RZ1D1S-2	
		√	√	√	√	√	√	√	√	√	√	√	RZ1D1B-2	
		√	√	√	√	√	√	√	√	√	√	√	RZ1D1R-2	
220V AC		√	√	√	√	√	√	√	√	√	√	√	RZ1D1S-5	
		√	√	√	√	√	√	√	√	√	√	√	RZ1D1B-5	
		√	√	√	√	√	√	√	√	√	√	√	RZ1D1R-5	

Numërator digjital

Tensioni i Operimit	Counter entry	Reset entry	Kodi	Çmimi
24V AC/DC	12-30V DC	12-30V DC	RZ4D1C208P	
	12-30V DC	12-30V DC	RZ4D1C208K	
220V AC	12-30V DC	12-30V DC	RZ4D1C508P	
	12-30V DC	12-30V DC	RZ4D1C508K	

Rele kohe digjitale

Tensioni i Operimit	Koha	Funksione										Kodi	Çmimi	
		A	B	F1	F2	S1	S2	S3	S4	I	P			R
24V AC/DC		√	√	√	√	√	√	√	√	√	√	√	RZ4D1S208P	
		√	√	√	√	√	√	√	√	√	√	√	RZ4D1B208P	
230V AC	0.1sek-99.99ore	√	√	√	√	√	√	√	√	√	√	√	RZ4D1R208P	
		√	√	√	√	√	√	√	√	√	√	√	RZ4D1S508P	
		√	√	√	√	√	√	√	√	√	√	√	RZ4D1B508P	
		√	√	√	√	√	√	√	√	√	√	RZ4D1R508P		



- A Rele ndezëse
- B Rele fikëse
- F1 Flash ne momentin e ndezjes
- F2 Flash ne momentin e fikjes
- S1 Funkcion për matjen e kohës së energjise kur i jep start
- S2 Funkcion për të shtyrë matjen e kohës së energjise kur i jep start
- S3 Funkcion për matjen e kohës së energjise kur i jep pause
- S4 Funkcion për të shtyrë matjen e kohës së energjise kur i jep start (2)
- I Funkcion ndalues
- P Mundësi nisjeje nga paneli qendror
- R Ruajtje të dhënash

Rele digjitale kohe ESM-3735

EZM-3735 është një rele kohe shumë funksionale dhe e lehtë në përdorim. Ka një kontakt dalje 5A për kontrollin e kohës (ON-OFF). Mundësia e nisjes dhe ndalimit nga paneli i përparmë. Ekrani mund të rregullohet për të shfaqur Sekondën, Minutën dhe Orën. Bazat kohore të programueshme (sekondë, minutë, orë) Mbrojtja me fjalëkalim për seksionin e programimit Me markë CE sipas normave evropiane.

Kodi	Voltazhi	Output Rele	Çmimi
EZM-3735.3.00.0.1	24 AC	5A	
EZM-3735.5.00.0.1	230 AC	5A	

Rele kohe dhe numerator digjital kohe EZM-4450

EZM-4450 është një kohëmatës dhe numërues për makineritë e paketimit, prodhimit dhe kontrollit të cilësisë si dhe për makinat prerëse dhe përpunuese. Numëruesi mund të vendoset në numëruesin e paracaktuar/totalizues, numërues grupi, kohëmatës, kronometër ose matës/takometër të frekuencës. Banaku mund të përshtatet lehtësisht me sistemet mekanike dhe automatike. Në versionin bazë, sporteli ka një ndërfaqe komunikimi. Numërimi mund të zgjerohet me module dalje nëpërmjet dy slotave. Modulet e daljes EMO-400 disponohen në versionet e daljes rele, daljes SSR dhe daljes së transistorit.

Kodi	Voltazhi	Lidhja	HI Outout Modul 2	Çmimi
EZM-4450.1.00.2.0/00.01	100.240V AC	RS-485	EMO-400 EMO-700 EMO-900	

Rele kohe dhe numerator digjital kohe EZM-9950

EZM-9950 është një kohëmatës dhe numërues për makineritë e paketimit, prodhimit dhe kontrollit të cilësisë si dhe për makinat prerëse dhe përpunuese. Numëruesi mund të vendoset në numëruesin e paracaktuar/totalizues, numërues grupi, kohëmatës, kronometër ose matës/takometër të frekuencës. Banaku mund të përshtatet lehtësisht me sistemet mekanike dhe automatizimi. Në versionin bazë, sporteli ka një ndërfaqe komunikimi. Numërimi mund të zgjerohet me module dalje nëpërmjet dy slotave. Modulet e daljes EMO-400 disponohen në versionet e daljes rele, daljes SSR dhe daljes së transistorit.

Kodi	Voltazhi	Lidhja	HI Outout Modul 2	Çmimi
EZM-9950.1.00.2.0/00.01	100.240V AC	RS-485	EMO-400 EMO-700 EMO-900	



Tachometer digjital kohe ERM-3770-N

Puna me grupin e procesit dhe vlerën e caktuar të alarmit.
 Dalja e alarmit.
 Kufiri i vlerës së caktuar të alarmit.
 Presjet dhjetore e rregullueshme.
 Sinjali i hyrjes nga 0,07 Hz deri në 10000 Hz.
 Marrja e mostrave automatike (1 sekondë deri në 16 sek).
 Mbrojtja me fjalëkalim në modalitetin e programimit.
 Mbrojtja me fjalëkalim për seksionin e programimit.
 Me markë CE sipas normave evropiane.



Kodi	Voltazhi	Punon me sensor	Pershkrimi	Çmimi
ERM-3770-N-5	230V AC	PNP-NPN	Tachometer	

Numerator digjital EYM-4430

EYM-4430 është ideal për përdorim në proceset e prodhimit.
 Numëruesi shumëfunksional numëron lart, poshtë ose lart e poshtë në varësi të cilësisimit. Hyrjet e numëruesit A dhe B janë të përshtatshme për lidhjen e çelsave, koduesve rrotullues, sensorëve kapacitiv ose ndërprerësve të afërsisë. Me daljen e integruar 12 V DC, mund të furnizohen sensorë ose kodues rrotullues.



Kodi	Voltazhi	Rele Output	Punon me sensor	Çmimi
EYM-4430.5	230V AC	1	PNP-NPN	

Numerator digjital i shpejtësisë së lartë EYM-4931 200khz

Numërues i shpejtësisë së lartë i programueshëm 200 KHZ.
 Ekran i vlerës së procesit (PV) me 6 shifra dhe Set (SV) me 6 shifra.
 Operacioni me 2 Vlera të Përcaktuara.
 Rivendosja, pauza dhe hyrjet e numërimit ChA-ChB.
 Funkionimi me rivendosje automatike dhe manuale.
 Llojet e hyrjes NPN/PNP.
 x1 / x2 / x4 Vetia e zhvendosjes së fazës.
 Koeficienti i shumëzimit, Koeficienti i Pjestimit dhe Pika Pozicioni.
 Parametrik , Dy pikë (shkallë e ulët - shkallë e lartë) dhe (Shumëzimi - Koeficienti i pjesëtimit).
 RS-232 Komunikimi Serial me Protokollin Modbus RTU
 Frekuenca e hyrjes Max. 200 kHz Max.
 Zgjedhja e frekuencës së hyrjes.



Kodi	Volt	Komunikim	Rele dalje	Encoder	Çmimi
EYM-4931.2.00.1.1/01	24V AC/DC	RS-232 ModBus	2R x 5A	12V DC	



Relle Kohe 48x48 sekonda,minuta dhe ore				
Tensioni i operimit	Amperazhi	Koha e Matjes	Kodi	Çmimi
24-220 AC	5A 220V AC	0.05 s -300 h	H3CR-A8/220	
12-48AC/DC	5A 220V AC	0.05 s -300 h	H3CR-A8/48	



Numërorë me impulse				
Tensioni i operimit	Amperazhi	Hapsira e numerimit	Kodi	Çmimi
12-380 AC	5A 220V AC	0-9999 x1/x10/x100	DH48J/380	
12-48AC/DC	5A 220V AC	0-9999 x1/x10/x100	DH48J/48	



Relle Kohe 24 oreshe					
Tensioni i operimit	Rezistenca	Bateri	Min kohes	Kodi	Çmimi
24-250V AC	16A 220V AC	150 ORE	30 min	SUL181H	
24-250V AC	16A 220V AC	PA BATERI	30 min	SUL161H	
110-230V AC	16A 220V AC		15 min	SUL181D	



Ampermetra analog class 1.5				
Tensioni i operimit	Amperazhi	Permasat	Kodi	Çmimi
AC	0-100A	96x96 mm	YC96/100A	
DC	0-15 Amper	48x45 mm	AL231A	



Voltmetra analog class 1.5 dhe 2.5				
Tensioni i operimit	Hapsira e marjes	Permasat	Kodi	Çmimi
AC	0-600 V	96x96	YC96/600V	
DC	0-30V	48x45	IC-230A	



Koha mates i oreve te punes				
Tensioni i operimit	Permasat	Hapsira e numerimit	Kodi	Çmimi
220V AC	48x48x40	0-99,999.99 h	BZ142-A	

Siguresa dhe suporte 2-32 Amper gG

CNC

Siguresa 100				
Permasat	Amperazhi	Capacity	Kodi	Çmimi
10.3x38	2	100 kA	R015/2A	
10.3x38	4	100 kA	R015/4A	
10.3x38	6	100 kA	R015/6A	
10.3x38	10	100 kA	R015/10A	
10.3x38	16	100 kA	R015/16A	
10.3x38	20	100 kA	R015/20A	
10.3x38	25	100 kA	R015/25A	
10.3x38	32	100 kA	R015/32A	



Siguresa 100			
Per siguresa	Pole	Kodi	Çmimi
10x38	1 P	RT18-32X1P	
10x38	2 P	RT18-32X2P	
10x38	3 P	RT18-32X3P	



Siguresa 2-32 Amper gG

ITALWEBER

Siguresa 10x38				
Permasat	Amperazhi	Kapaciteti	Kodi	Çmimi
10.3x38	2	120 kA	ITW1421002	
10.3x38	4	120 kA	ITW1421004	
10.3x38	6	120 kA	ITW1421006	
10.3x38	10	120 kA	ITW1421010	
10.3x38	16	120 kA	ITW1421016	
10.3x38	20	120 kA	ITW1421020	
10.3x38	25	120 kA	ITW1421025	
10.3x38	32	120 kA	ITW1421032	



Suporte për siguresa

Schneider Electric

Suporte për siguresa			
Per siguresa	Pole	Kodi	Çmimi
10x38	1 P	A9N15636	
10x38	2 P	A9N15651	
10x38	3 P	A9N15638	





Kapaciteti kontaktit	Rezistenca e kontaktit	Rele		
		Nr kontakteve	Kodi	Cmimi
10A-30VDC /220VAC	50mΩ (1A 16V DC)	2CO / 8P	55.02Z-24DC	
10A-30VDC /220VAC	50mΩ (1A 16V DC)	2CO / 8P	55.02Z-24AC	
10A-30VDC /220VAC	50mΩ (1A 16V DC)	2CO / 8P	55.02Z-48AC	
10A-30VDC /220VAC	50mΩ (1A 16V DC)	2CO / 8P	55.02Z-110AC	
10A-30VDC /220VAC	50mΩ (1A 16V DC)	2CO / 8P	55.02Z-220AC	
5A-30VDC /220VAC	50mΩ (1A 16V DC)	4CO / 14P	55.04Z-24DC	
5A-30VDC /220VAC	50mΩ (1A 16V DC)	4CO / 14P	55.04Z-24AC	
5A-30VDC /220VAC	50mΩ (1A 16V DC)	4CO / 14P	55.04Z-48AC	
5A-30VDC /220VAC	50mΩ (1A 16V DC)	4CO / 14P	55.04Z-110AC	
5A-30VDC /220VAC	50mΩ (1A 16V DC)	4CO / 14P	55.04Z-220AC	



Kapaciteti kontaktit	Rezistenca e kontaktit	Rele		
		Nr kontakteve	Kodi	Cmimi
10A-28VDC / 220VAC	50mΩ (1A 16V DC)	2CO / 8P	60.12Z-24DC	
10A-28VDC / 220VAC	50mΩ (1A 16V DC)	2CO / 8P	60.12Z-24AC	
10A-28VDC / 220VAC	50mΩ (1A 16V DC)	2CO / 8P	60.12Z-48AC	
10A-28VDC / 220VAC	50mΩ (1A 16V DC)	2CO / 8P	60.12Z-110AC	
10A-28VDC / 220VAC	50mΩ (1A 16V DC)	2CO / 8P	60.12Z-220AC	
5A-28VDC /220VAC	50mΩ (1A 16V DC)	3CO / 11P	60.13Z-24DC	
5A-28VDC /220VAC	50mΩ (1A 16V DC)	3CO / 11P	60.13Z-24AC	
5A-28VDC /220VAC	50mΩ (1A 16V DC)	3CO / 11P	60.13Z-48AC	
5A-28VDC /220VAC	50mΩ (1A 16V DC)	3CO / 11P	60.13Z-110AC	
5A-28VDC /220VAC	50mΩ (1A 16V DC)	3CO / 11P	60.13Z-220AC	



Kapaciteti kontaktit	Voltazhi	Rele		
		Nr kontakteve	Kodi	Cmimi
12A- 28VDC /277VAC	12 VDC	2CO / 8P	RXM2AB2JD	
12A- 28VDC /277VAC	24VDC	2CO / 8P	RXM2AB2BD	
12A- 28VDC /277VAC	24VAC	2CO / 8P	RXM2AB2B7	
12A- 28VDC /277VAC	48VAC	2CO / 8P	RXM2AB2E7	
12A- 28VDC /277VAC	230VAC	2CO / 8P	RXM2AB2P7	
6A- 30VDC /277VAC	24VDC	4CO / 14P	RXM4AB2BD	
6A- 30VDC /277VAC	24VAC	4CO / 14P	RXM4AB2B7	
6A- 30VDC /277VAC	48VAC	4CO / 14P	RXM4AB2E7	
6A- 30VDC /277VAC	120VAC	4CO / 14P	RXM4AB2F7	
6A- 30VDC /277VAC	230VAC	4CO / 14P	RXM4AB2P7	

 Kodi PYF08A-E
 Çmim

 Kodi PYF14A-E
 Çmim

 Kodi PF083A-E
 Çmim

 Kodi PF113A-E
 Çmim



RELE DHE ANALIZATORË



Mates energjie (sahat)
Çfarë janë dhe ku përdoren?

Matësit e energjisë janë zgjidhje kompakte njëfazore që përdoren për të matur konsumin e energjisë aktive në impiantin ose kompaninë tuaj. Mund të përdoren te Qendrat Tregtare, Aeroportet, Stacionet e Trenit, Fabrikat, Vendet e Ndërtimit, Dyqanet, Spitalet, Shkollat, Fshatrat e Pushimeve, Marinat, Sallat e Ekspozitave Industriale etj.



Kodi	Fuqia	Ct-80d	Rs 485 comm	Energjia dalese	Çmimi
ES-32L	32 A			✓	
ES-32LS	32 A		✓		
ES-45L	45 A			✓	
ES-45LS	45 A		✓		
ES-80L	80 A	✓		✓	
ES-80LS	80 A	✓	✓		

Mates energjie 3 faze i serise ES3
Ku përdoren?

Matësit e energjisë 3-fazorë të serisë ENTES ES3 mbulojnë të gjitha kërkesat me monitorimin e tyre të energjisë dhe veçoritë e aplikacionit të faturimit në ndërtesa komerciale dhe rezidenciale, qendra tregtare, qendra të dhënash. Kursejne kohen me shpërndarje dhe faturim të lehtë në projektet e banesave masive. Seria ES3 ofrojnë matjen dhe monitorimin e parametrave elektrike si rryma, tensioni, fuqia dhe kërkesa maksimale në objektet industriale.



Kodi	Voltazhi	Rryma	Frekuen	Konsumi energjise	Çmimi
ES3-63LS	85-265V	0,02-63A	45-75 Hz	<10VA	
ES3-63LSE	85-265V	0,02-63A	45-75 Hz	<10VA	
ES3-80LS	85-265V	0,02-80A	45-75 Hz	<10VA	
ES3-80LSE	85-265V	0,02-80A	45-75 Hz	<10VA	

Rele kohe astronomike
Çfarë është releja astronomike?

Reletë astronomike të kohës janë stafetë inteligjente kohore të cilat janë të afta të llogaritin automatikisht orët e lindjes dhe perëndimit të diellit dhe kanë orë të brendshme në kohë reale. Ato janë krijuar për të kontrolluar pajisjet që lidhen me kontaktet e daljes në oraret e përcaktuara nga përdoruesi, oraret e lindjes dhe perëndimit të diellit. Ju mund te regjistroni qytetin si dhe oren dhe ajo e gjen vet kohen kur lind dhe perendon dielli.



Kodi	Program 24h	1 rele në dalje	2 rele në dalje	Program	H program	Çmimi
DRT-10	✓		✓	15		
DRT-10T	✓	✓		15		
DTR-20	✓		✓	32	✓	

Rele analoge per mbrojtje motori

Reletë e dështimit të fazës janë krijuar për të monitoruar motorët trefazorë kundër mbinxehjes dhe dëmtimit të shkaktuar nga defektet e fazës dhe çekuilibri i tensionit në impiantet industriale.

1. Kur renditja e fazeve (L1,L2,L3) nuk është e saktë, releja stakon daljen.
2. Në rast të një defekti në ndonjë nga fazat, kontakti i daljes fiket.
3. Nëse temperaturat e bobines në motor tejkalojnë vlerën e kufirit të temperaturës PTC, releja e daljes fiket automatikisht.
4. Asimetria e fazes me regjistrim ben te mundur regjistrimin ne % te renies se fazes si dhe per sa kerkon do stakohet.



Kodi	Humbja neutrit	Humbja fazës	Renditja I1, I2, I3	Ptc rele temperature	Asimetria e fazës >20%	Asimetria e fazës regjis	Kontakti dalës	Çmimi
MKC-03	√	√	√		√		1 N/O	
MKC-03P	√	√	√	√	√		1 C/O	
MKS-05	√	√	√			√		
MKS-05P	√	√	√	√		√		

Rele kohe analoge

Kodi	Koha	Ndezja	Fikja	Çmimi
MCB-7	0.1sec-30 h	√	√	
MCB-8	0.1sec-999min	√	√	
MCB-9	0.5sec-30h	√	√	
MCB-30	2-30SEC	√		
MCB-60	4-60SEC	√		

Rele kohe analoge (yll trekëndësh)

Kodi	Koha	On-off	Funksioni	Çmimi
MCB-15	0.05sec-100h	√	4	
MCB-20	0.1sec-100h	√	7	
MCB-25	0.1sec-999h	√	8	
SER-YU	YII(1-60sek) YII-Δ(20-500msec)			

Rele per nivelin e lengjeve

Kodi	kΩ	Din2rail	Support	Çmimi
SSRC-04	5-50	√		
SSRC-04P	2-100		√	
LLS-02				



Analizator rrjeti MPR

Tension 50-270 V AC/DC, Përmasa 96-96-45mm

Me dizajnin e tyre kompakt dhe thellësinë 45 mm, analizuesit e rrjetit të gjeneratës së re të serisë MPR-4 zënë më pak hapësirë në centrale dhe kanë një gamë të gjerë të tensionit operativ (50-270 VAC / DC).

Përveç memorjes së brendshme deri në 16 MB, ato ofrojnë zgjidhje të gjera I/O me strukturën e tyre modulare të zëvendësueshme bazuar në kërkesat e klientëve dhe fushat e aplikimit.

Seritë MPR-4 ofrojnë një gamë të gjerë hyrjesh/daljesh analoge dhe dixhitale dhe dalje rele me modulet e tyre I/O.

Kodi	Mat 3xV, 3xI, hz, cos	Energji clas 1	% THD-I % THD-V	Input korrent N	Rs 485	Alarm	Rtc (ora)	Ore mates	Çmimi
MPR-45	✓	✓		✓		✓	✓	✓	
MPR-45S	✓	✓		✓	✓	✓	✓	✓	
MPR-46	✓	✓	✓	✓		✓	✓	✓	
MPR-46S	✓	✓	✓	✓	✓	✓	✓	✓	
MPR-47S	✓	✓	✓	✓	✓	✓	✓	✓	

Analizator rrjeti EMR

Tension 100-270 V AC/DC, Përmasa 96-96-45mm

Specifikimet e Përgjithshme:

- Gama e gjerë e furnizimit
- Dizajn i hollë për panele të ngushta
- Matja e rrymës 3-fazore të tensionit 3-fazor
- Memorie e brendshme 2 MB
- Opsionet e alarmit (bazuar në model)
- Ora në kohë reale (baza e modelit)
- Ora e vrapimit
- 2x dalje rele (bazuar në model)
- 2x dalje dixhitale 2x hyrje dixhitale (opsionale)
- Komunikimi Modbus (bazuar në model)
- Montimi i panelit 96 x 96

Kodi	Energjia clas 1	Kerkesa min/max	% THD-I % THD-V	Programe	Rs 485	Output digjital	Rele outputi	Memorje	Çmimi
EMR-53	✓	✓	✓	15		2		2MB	
EMR-53S	✓	✓	✓	32	✓	2		2MB	
EMR-53CS	✓	✓	✓	32	✓	2	✓	2MB	

Power factor controller
Tension 100-270 V AC/DC, Përmasa 144x144

Kontrollorët e faktorit të fuqisë reaktive përpiqen të përputhen me faktorin e fuqisë së sistemit, i cili përcaktohet si raporti i fuqisë aktive ndaj fuqisë së dukshme ndaj vlerës së faktorit të fuqisë të përcaktuar nga përdoruesi.



Kodi	Përmasa	Programe	Lloji i ekranit	1 fazë, 1 transformator	Kondensator 3 fazor	Çmimi
RG-6T	96x96	6	led	✓	✓	
RG-6T	144x144	6	led	✓	✓	
RG-8T	144x144	8	led	✓	✓	
RG-12T	144x144	12	led	✓	✓	

Multimetër paneli EMM
Tension 100-270 V AC/DC, Përmasa 96X96

Multimetrat ENTES janë projektuar për të matur parametrat elektrikë si rryma, tensioni, frekuenca dhe cos në impiantet industriale.



Kodi	3 faze V 3 faze I	Frek (Hz) neutr (I)	Cos	Frek	Rryma neutrale	Alar	Mbrojtja sek. fazes	Mbrojtje nen/mbi V/F	Çmimi
EMM-04-96	✓	✓	✓	✓	✓				
EMM-04C-96	✓	✓	✓	✓	✓	✓	✓	✓	
EMM-04CS-96	✓	✓	✓	✓	✓	✓	✓	✓	
EPM-04-96	✓	✓		✓	✓				
EPM-04h-96	✓	✓		✓	✓				
EPM-06C-96	✓	✓	✓	✓	✓	✓	✓	✓	

Transformatorë rryme 30mm

Transformatorët e rrymës së serisë ENT janë pajisje me profil të ngushtë për të reduktuar rrymën e linjës në një nivel të pranueshëm për instrumentet matëse. Ata gjithashtu izolojnë dhe mbrojnë instrumentet matëse, reletë dhe njehsorët e tjerë nga tensioni i linjës së një instalimi.



(A) Primari	Sekondari (VA) Fuqia Nominale	5A Klasi			Çmimi
		3	1	0.5	
		50	1.25	x	
60	1.5	x	√	x	
75	1.5	x	√	x	
80	2.5	x	√	x	
100	1.5	x	x	√	
	2.5	x	√	x	
125	2.5	x	x	√	
	2.5	x	√	x	
150	2.5	x	√	x	
	2.5	x	x	√	
200	2.5	x	x	√	
250	2.5	x	x	√	
	5	x	x		
300	5	x	x	√	
400	5	x	x	√	
500	5	x	x	√	

Transformatorë rryme te llojit dare

Transformatorët aktualë të serisë ENS ofrojnë avantazhin e operacionit me një dorë. Në këtë mënyrë seritë ofrojnë montim dhe çmontim të sigurtë dhe të lehtë pa ndërprerë energjinë.



Kodi	(A) Primari	Sekondari (VA) Fuqia Nominale	5A Klasi			Çmimi
			3	1	0.5	
-						
ENS.CCT 24 100A/5	100	1	√	x	x	
ENS.CCT 24 150A/5	150	1,5	√	x	x	
ENS.CCT 24 200A/5	200	0,5	x	√	x	
ENS.CCT 24 250A/5	250	0,5	x	√	x	
ENS.CCT 24 300A/5	300	0,5	x	√	x	
ENS.CCT 24 400A/5	400	0,5	x	√	x	
ENS.CCT 36 300A/5	300	1,5	x	√	x	
ENS.CCT 36 400A/5	400	0,5	x	x	√	
ENS.CCT 36 500A/5	500	0,5	x	x	√	
ENS.CCT 36 600A/5	600	0,5	x	x	√	

9

KONTROLLUES TEMPERATURE & SENSORË



Kontrollues temperature ESM-3710-N (76x34.5x71mm)

Ky version sherben per kontrollin e temperatures ne ngrohje dhe ftohje. Ka perdorim te gjere te furrat, dhoma frigoriferike , industri etj.

Kodi	Permasa ne mm	Voltazhi	Sensori	Rele dalje	Rele SSR	Çmimi
ESM3710-N.3.05	76 X 34.5	24 AC	J=0-800	1	jo	
ESM3710-N.3.11	76 X 34.5	24 AC	PT=-50...400	1	jo	
ESM3710-N.5.05	76 X 34.5	230 AC	J=0-800	1	jo	
ESM3710-N.5.11	76 X 34.5	230 AC	PT=-50...400	1	jo	

Kontrollues temperature ESM-3711-HN (76x34.5x71mm)

Ky version sherben per kontrollin e temperatures ne ngrohje. Ka perdorim te gjere te furrat, industri etj. Kontrolluesi eshte ideal per kontrollin e temperatures me ane te kohes dhe jep alarm kur mbaron procesi.

Kodi	Permasa ne mm	Voltazhi	Sensori	Rele dalje	Rele SSR	Çmimi
ESM3711-HN.3.05	76 X 34.5	24 AC	J=0-800	1	jo	
ESM3711-HN.5.05	76 X 34.5	230 AC	J=0-800	1	jo	

Kontrollues temperature ESM-3712-HCN (76x34.5x71mm)

Ky version sherben per kontrollin e temperatures ne ngrohje dhe ftohje. Ka dy rele dalje njera 16A dhe tjetra 5A. Permban dalje Alarmi dhe sinjalizues te brendeshem Ka perdorim te gjere te furrat, dhoma frigoriferike , industri etj.

Kodi	Permasa ne mm	Voltazhi	Sensori	Rele dalje	Rele SSR	Çmimi
ESM3710-HCN.3.05	76 X 34.5	24 AC	J=0-800	2	jo	
ESM3710-HCN.5.05	76 X 34.5	230 AC	J=0-800	2	jo	

Kontrollues lagështie dhe temperature per inkubator ESM-3722 (76 x 34.5 X 71mm)

Kontrollues temperature dhe i Lageshtise Inkubator ESM-3722. Ky version sherben per kontrollin e temperatures dhe lageshtisë te inkubatorete, serat , muzete etj. Detajon temperaturen deri ne 0.05°C. Ka sistem PID per limitin temperature maksimale, minimale dhe stabilizimin. Sensori i cili eshte i perfshire ne kuti ben matjen e temperatures dhe lageshtisë njekohesisht. Tabakaja e vezeve ka funksionon manualisht nga paneli perpara.



Kodi	Voltazhi	Rele ngrohje	Input-Sensor	Perfshire	Output Rele	Rele Lageshtije	Çmimi
ESM3722.3.6	24 AC	5 Amper	PMI-P	PMI-F	✓	✓	
ESM3722.5.6	230 AC	5 Amper	PMI-P	PMI-F	✓	✓	

Kontrollues lagështie dhe temperature per brumin ESM-3723 (76x34.5x71mm)

Kontrollues temperature dhe Lageshtie per dhomat e ardhjes se brumit ESM-3723. Ky version sherben per kontrollin e temperatures dhe lageshtis te dhomat , serrat etj. Ka sistem PID per limitin temperature maksimale, minimale dhe stabilizimin. Sensori i cili eshte i perfshire ne kuti, ben matjen e temperatures dhe lageshtis njekohesisht



Kodi	Voltazhi	Rele ngrohje	Input-Sensor	Perfshire	Output Rele	Rele Lageshtije	Çmimi
ESM3723.3.6	24 AC	5 Amper	PMI-F	PMI-F	✓	✓	
ESM3723.5.6	230 AC	5 Amper	PMI-F	PMI-F	✓	✓	

Kontrollues temperature ESM-9945 per kuzhina industriale (96x96x87.5mm)

ESM-9945 me dalje avulli Zgjedhja e formularit të kontrollit të ndezur/fikur ose proporcionale. Pt-100 Hyrja e temperaturës me 2 tela ose 3 tela. Termoçifti i tipit J, termoçifti i tipit K. Zgjedhja e kohës së punës në minuta ose sekonda. Rregullimi i histerezës. Alarmi dëgjueshëm nga sinjalizuesi brendshëm. Hyrja e çelësit të derës.



Kodi	Voltazhi	Input Sensor	Rele temperature	Rele e kohes	Rele e avullit	Çmimi
ESM9945.3.05.0.1/01.01/1	24 AC	J=0...800	7A	7A	7A	
ESM9945.5.05.0.1/01.01/1	230 AC	J=0...800	7A	7A	7A	

Eco LITE 4 Kontrollues temperature universal 48x48mm

Kontrollues temperature universal ECO LITE. Fuksionon me te gjithë sensoret (TC);J, K, R, S, dhe L por dhe per sensoret (RTD): Cu-50 dhe PT-100. Funkzioni i zgjedhur i ngrohjes dhe ftohjes Vlera e zgjidhshme e kompensimit të temperaturës



Kodi	Voltazhi	Inputi	Rele Output	Çmimi
Eco LITE.4.6.1R	10-30VDC	TC-RTD	1R(NO+C) 5A	
Eco LITE.4.2.1R	24V AC/DC	TC-RTD	1R(NO+C) 5A	
Eco LITE.4.2.2R	24V AC/DC	TC-RTD	2R(2NO+C) 5A	
Eco LITE.4.5.1R	230V AC	TC-RTD	1R(NO+C) 5A	
Eco LITE.4.5.2R	230V AC	TC-RTD	2R(2NO+C) 5A	

Eco PID 4 Kontrollues temperature universal 48x48mm i ndjeshem dhe me rezulucion te lart

PID



Kontrollues temperature universal ECO PID me rezulucion te lart. Konsum i ulet i energjisë. Format e kontrollit ON-OFF, P, PI, PD, PID të programueshëm. Funkzioni i zgjedhur i ngrohjes dhe ftohjes etj.

Kodi	Voltazhi	Inputi	Rele Output	Çmimi
Eco PID.4.2.1R.S	24V AC/DC	TC-RTD	1Rele 5A+SSR	
Eco PID.4.2.2R.S	24V AC/DC	TC-RTD	2Rele 5A+SSR	
Eco PID.4.5.1R.S	230V AC	TC-RTD	1Rele 5A+SSR	
Eco PID.4.5.2R.S	230V AC	TC-RTD	2Rele 5A+SSR	

ESM-4435 Kontrollues procesi universal 48x48mm

PID



Kontrollues procesi universal ESM-4435 . Kontrolluesi universal i procesit të hyrjes PID. Input universal (TC);J, K, R, S, dhe L por dhe per sensoret (RTD): Cu-50 dhe PT-100.
 - Kalibrim i dyfishtë ose me shumë pika për hyrjen e tensionit Z / rrymës
 - Format e kontrollit ON/OFF, P, PI, PD dhe PID të konfigurueshme
 - Zgjedhja manuale/automatike e modalitetit për daljet e kontrollit
 - Funkcionet e programueshme të ngrohjes, ftohjes dhe alarmit për daljet

Kodi	Voltazhi	Inputi universal	Rele Output 1-2	Rele Output	Çmimi
ESM-4435.1.20.1/01.01	100-240V AC	TC-RTD	2 RELE/ 5A	1 RELE/ 5A	
ESM-4435.2.20.1/01.01	24V AC/DC	TC-RTD	2 RELE/ 5A	1 RELE/ 5A	
ESM-4435.2.20.1/01.04	24V AC/DC	TC-RTD	2 RELE/ 5A	1 Analog (0/4 ...20mA, 0-10Vdc	

ESM-XX10 Kontrollues temperature me permasa 48x48 /72x72 /96x96 mm

Kodi	Voltazhi	Permasa ne mm	Inputi	Inputi	Rele Output	Çmimi
ESM-4410.5.03	220V AC	48x48	PT-100	0-400°C	1R-7A	
ESM-4410.5.05	220V AC	48x48	J	0-800°C	1R-7A	
ESM-7710.3.03	24V AC	72x72	PT-100	0-400°C	1R-7A	
ESM-7710.3.05	24V AC	72x72	J	0-800°C	1R-7A	
ESM-7710.5.03	220V AC	72x72	PT-100	0-400°C	1R-7A	
ESM-7710.5.05	220V AC	72x72	J	0-800°C	1R-7A	
ESM-9910.3.03	24V AC	96x96	PT-100	0-400°C	1R-7A	
ESM9910.3.05	24V AC	96x96	J	0-800°C	1R-7A	
ESM-9910.5.03	220V AC	96x96	PT-100	0-400°C	1R-7A	
ESM-9910.5.05	220V AC	96x96	J	0-800°C	1R-7A	

ESM-XX20 Kontrollues temperature universal me dy rele dalje + SSR

Kontrollues temperature universal ECO PID me rezulucion te lartë.
 Konsum i ulet i energjisë.
 Format e kontrollit ON-OFF, P, PI, PD, PID të programueshëm.
 Funksioni i zgjedhur i ngrohjes dhe ftohjes etj.

Kodi	Voltazhi	Permasa ne mm	Inputi	Rele Output	Çmimi
ESM-4420.2.20	24V AC/DC	48x48	TC-RTD	2R-5A+SSR	
ESM-4420.5.20	220V AC	48x48	TC-RTD	2R-5A+SSR	
ESM-7720.2.20	24V AC/DC	72x72	TC-RTD	2R-5A+SSR	
ESM-7720.5.20	220V AC	72x72	TC-RTD	2R-5A+SSR	
ESM-9920.2.20	24V AC/DC	72x72	TC-RTD	2R-5A+SSR	
ESM-9920.5.20	220V AC	72x72	TC-RTD	2R-5A+SSR	

ESM-9945N Kontrollues temperature universal (96x96x87.5mm)

Kontrollues temperature universal ECO PID me rezulucion te lartë.
 Konsum i ulet i energjisë.
 Format e kontrollit ON-OFF, P, PI, PD, PID të programueshëm.
 Funksioni i zgjedhur i ngrohjes dhe ftohjes etj.

Kodi	Voltazhi	Permasa ne mm	Inputi	Rele Output	Çmimi
ESM-9920.2.20	24V AC/DC	72x72	TC-RTD	2R-5A+SSR	
ESM-9920.5.20	220V AC	72x72	TC-RTD	2R-5A+SSR	



Kontrollues furre tek

- 8 butona për të bërë programe të ndryshme, 2 hyrje termokupli i izoluar J ose K (Duhet të përcaktohet sipas radhës)
- Funksioni i nisjes automatike në kohë reale
- Kontrolli i temperaturës ON / OFF për 2 zona
- Kompensimi i rregullueshëm i temperaturës
- Zgjedhja e operacionit me histerezë
- 4 ekrane që kanë 3 shifra dhe 2 ekrane që kanë 4 shifra (Për orën)
- Daljet e stafetës për të kontrolluar 2 Ngrohës (jo/nc),
- 4 Fans, Brulor, Steam, Llama dhe Time-Out
- 1 hyrje e statusit të derës dhe 1 hyrje e dështimit brulor
- Mbrojtja me fjalëkalim për modalitetin e programimit

Veçoritë	Përshkrimi	Çmimi
Tensioni dhe fuqia e operimit	230 Vac(+%15) 50/60 Hz. 1.5 VA 24 Vac (+%15) 50/60 Hz. 1.5 VA	
Sensori inputit	Termokupl J, K (IEC584.1)(ITS90)	
Shkalla	Fe CuNi 0°C...800°C NiCr 0°C...999°C	
Saktësia	± % 1 e shkallës së plotë	
Relea e daljes	10A@250 Vac for heating control, 8 x 8A@250Vac Fan, steam, lighting, time, cooling	
Forma e kontrollit	3 lexime në sekondë	

Kontrollues furre dysh

- 8 butona për të bërë programe të ndryshme, 2 hyrje termokupli i izoluar J ose K (Duhet të përcaktohet sipas radhës)
- Funksioni i nisjes automatike në kohë reale
- Kontrolli i temperaturës ON / OFF për 2 zona
- Kufizimi i vlerës së caktuar
- Kompensimi i rregullueshëm i temperaturës
- Zgjedhja e operacionit me histerezë
- 4 ekrane që kanë 3 shifra dhe 2 ekrane që kanë 4 shifra (Për orën)
- Daljet e stafetës për të kontrolluar 2 Ngrohës (jo/nc),
- 4 Fans, Brulor, Steam, Llama dhe Time-Out
- 1 hyrje e statusit të derës dhe 1 hyrje e dështimit brulor
- Mbrojtja me fjalëkalim për modalitetin e programimit

Veçoritë	Përshkrimi	Çmimi
Tensioni dhe fuqia e operimit	230 Vac(+%15) 50/60 Hz. 1.5 VA 24 Vac (+%15) 50/60 Hz. 1.5 VA	
Sensori inputit	Termokupl J, K (IEC584.1)(ITS90)	
Shkalla	Fe CuNi 0°C...800°C NiCr 0°C...999°C	
Saktësia	± % 1 e shkallës së plotë	
Relea e daljes	10A@250 Vac for heating control, 8 x 8A@250Vac Fan, steam, lighting, time, cooling	
Forma e kontrollit	3 lexime në sekondë	

Sensore temperature TC=J 0-400 kabellii gjershetuar me fibra xhami

Kodi	Diametri	Gjersia e Kokës	Gjatesia e kabellit	Çmimi
TC-M06-L30-K01.J	6 mm	30 mm	1 m	
TC-M06-L30-K01,5J	6 mm	30 mm	1.5 m	
TC-M06-L30-K02.J	6 mm	30 mm	2 m	
TC-M06-L30-K03.J	6 mm	30 mm	3 m	
TC-M08-L012-K01.J	8 mm	12 mm	1 m	
TC-M08-L012-K01,5J	8 mm	12 mm	1.5 m	
TC-M08-L012-K02.J	8 mm	12 mm	2 m	

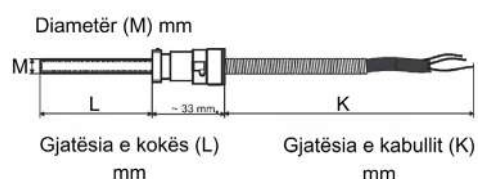
Sensore temperature RT=PT -50-400 kabelli i gjershetuar me fibra xhami

Kodi	Diametri	Gjersia e Kokës	Gjatesia e kabellit	Çmimi
RT-M06-L50-K01.J	6 mm	50 mm	1 m	
RT-M06-L50-K01,5J	6 mm	50 mm	1.5 m	
RT-M06-L50-K02.J	6 mm	50 mm	2 m	
RT-M06-L50-K03.J	6 mm	50 mm	3 m	
RT-M08-L012-K01.J	8 mm	12 mm	1 m	
RT-M08-L012-K01,5J	8 mm	12 mm	1.5 m	
RT-M08-L012-K02.J	8 mm	12 mm	2 m	

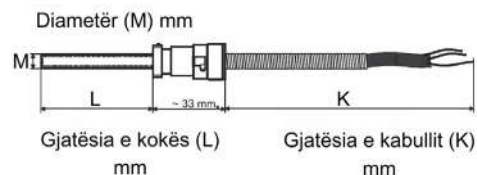

Sensore temperature per lengjet PTCS=PT -50....130 Kabelli me silikon

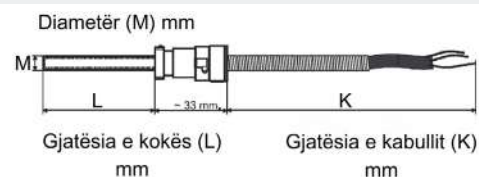
Kodi	Diametri	Gjersia e Kokës	Gjatesia e kabellit	Çmimi
PTCS-M6-L30.K1,5	6 mm	30 mm	1.5 m	



Kodi	Fuqia	Temperatura	Çmimi
JSL50-300	16A	50-300°C.	

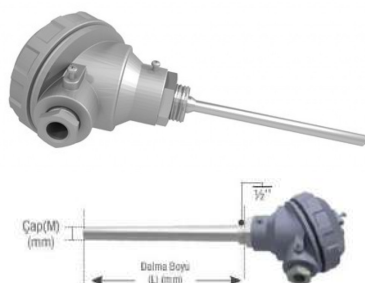

Sensore temperature

Kodi	Diametri i Kokes	Gjersia e Kokes	Tipi	Temp	Çmimi
RTKR-M06-L100.1	6 mm	100 mm	PT-100	-50.. 500°C	
RTKR-M06-L200.1	6 mm	200 mm	PT-100	-50.. 500°C	
RTKR-M06-L300.1	6 mm	300 mm	PT-100	-50.. 500°C	
RTKR-M08-L300.1	8 mm	300 mm	PT-100	-50.. 500°C	
TCKR-M06-L300.1.J	6 mm	300 mm	J	0..600°C	
TCKM-M06-L300.1.J	6 mm	300 mm	K	1200°C	

Sensore temperature TC=J 0-400 kabellii gërshetuar me fibra xhami

KU PËRDORET?

Për aplikimet më të zakonshme të sistemeve të ngrohjes, ventilimit dhe ajrit të kondicionuar, pronem mini transmetuesi i lagështisë dhe temperaturës në kontrollet e ventilimit dhe ajrit të kondicionuar, dhomat e ndenjes dhe zyrat, dhomat e magazinimit, serat, sallat e pishinave, stalla dhe në automatizimin e ndërtesave.

SPECIFIKIME TEKNIKE

- Gama e matjes së lagështisë relative të ajrit: 0 deri në 100%
- Saktësia e lagështisë relative: $\pm 2\%$ në 23°C
- Saktësia e temperaturës: $\pm 0,1\%$ në 23°C
- Tensioni i funksionimit 16 deri në 32 V DC
- Sinjali i daljes: 4-20 mA
- Temperatura e funksionimit: -40°C deri +85°C

KODI
PMI-P

CMIMI
6000

Sensore temperature TC=J 0-400 kabellii gërshetuar me fibra xhami

PMD-W

KU PËRDORET?

Për aplikimet më të zakonshme të sistemeve të ngrohjes, ventilimit dhe ajrit të kondicionuar, pronem mini transmetuesi i lagështisë dhe temperaturës në kontrollet e ventilimit dhe ajrit të kondicionuar, dhomat e ndenjes dhe zyrat, dhomat e magazinimit, serat, sallat e pishinave, stalla dhe në automatizimin e ndërtesave.



PMD-D

SPECIFIKIME TEKNIKE

- Gama e matjes së lagështisë relative të ajrit: 0 deri në 100%
- Saktësia e lagështisë relative: $\pm 2\%$ në 23°C
- Saktësia e temperaturës: $\pm 0,1\%$ në 23°C
- Tensioni i funksionimit 16 deri në 32 V DC
- Sinjali i daljes: 4-20 mA
- Temperatura e funksionimit: -40°C deri +85°C

Sensore temperature TC=J 0-400 kabellii gërshetuar me fibra xhami

PMDL-W

KU PËRDORET?

Për aplikimet më të zakonshme të sistemeve të ngrohjes, ventilimit dhe ajrit të kondicionuar, pronem mini transmetuesi i lagështisë dhe temperaturës në kontrollet e ventilimit dhe ajrit të kondicionuar, dhomat e ndenjes dhe zyrat, dhomat e magazinimit, serat, sallat e pishinave, stalla dhe në automatizimin e ndërtesave.



PMDL-D

SPECIFIKIME TEKNIKE

- Gama e matjes së lagështisë relative të ajrit: 0 deri në 100%
- Saktësia e lagështisë relative: $\pm 2\%$ në 23°C
- Saktësia e temperaturës: $\pm 0,1\%$ në 23°C
- Tensioni i funksionimit 16 deri në 32 V DC
- Sinjali i daljes: 4-20 mA
- Temperatura e funksionimit: -40°C deri +85°C

10

MUFTE DHE KABËLL

Muftë me raport 2/1, RSFR-H, fsibel, zjarrdurues



-55 +125

Gjendje normale Diametri Brendshëm	Pas tkurrjes		Paketimi	Kodi	Çmimi (lekë/metër)
	Diametri Brendshëm	Trashësia e murit	Rulon (meter)		
1.0	0.65	0.30	200	MFE010	
1.5	0.85	0.35	200	MFE015	
2.0	1.00	0.35	200	MFE020	
2.4	1.20	0.38	200	MFE025	
3.0	1.50	0.38	200	MFE030	
3.5	1.75	0.40	200	MFE035	
4.0	2.00	0.45	200	MFE040	
4.5	2.60	0.45	100	MFE045	
5.0	2.60	0.47	100	MFE050	
6.0	3.00	0.55	100	MFE060	
7.0	3.50	0.55	100	MFE070	
8.0	4.00	0.60	100	MFE080	
9.5	4.80	0.60	100	MFE100	
12.7	6.50	0.65	100	MFE130	
16.0	8.00	0.75	100	MFE160	
19.0	10.00	0.80	100	MFE190	
25.5	12.00	0.95	50	MFE255	
30.0	15.00	0.95	50	MFE300	

Muftë me raport 2/1, SBRS-(2X) G fsibel, zjarrdurues

-55 +125

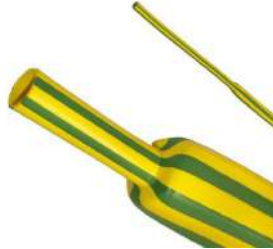
Gjendje normale Diametri Brendshëm	Trashësia	Pas tkurrjes		Paketimi	Kodi	Çmimi (lekë/metër)
		Trashësia e adesivit	Trashësia e murit	Rulon (metër)		
1.50	0.80	0.60±0.15	0.30±0.1	200	MF*015	
2.50	1.20	0.70±0.15	0.35±0.1	200	MF*025	
3.20	1.60	0.70±0.15	0.35±0.1	200	MF*032	
4.80	2.40	0.80±0.15	0.40±0.1	100	MF*048	
6.40	3.20	0.80±0.15	0.40±0.1	100	MF*064	
7.00	3.50	0.90±0.15	0.45±0.1	100	MF*070	
9.50	4.80	0.90±0.15	0.45±0.1	50	MF*095	
13.0	6.40	0.95±0.20	0.45±0.1	25	MF*130	
16.0	7.90	0.95±0.20	0.45±0.1	25	MF*160	

Mufte me raport 2/1, RSFR-(2X) YG, fsibel, zjarrdurrues

-55 +125

Gjendje normale	Pas tkurrjes			Paketimi	Kodi	Çmimi (lekë/metër)
Diametri Brendshëm	Diametri i brendshëm	Trashësia e adesivit	Trashësia e murit	Rulon (metër)		
2.40	1.20	0.28±0.15	0.35±0.10	200	MFE024VJ	
3.20	1.60	0.30±0.15	0.38±0.10	200	MFE032VJ	
4.80	2.40	0.70±0.15	0.45±0.10	200	MFE048VJ	
6.40	3.20	0.80±0.15	0.50±0.10	100	MFE064VJ	
9.50	4.80	0.80±0.15	0.55±0.10	100	MFE095VJ	
13.0	6.50	0.90±0.15	0.60±0.10	100	MFE130VJ	
16.0	8.00	0.90±0.15	0.70±0.10	50	MFE160VJ	
20.0	10.0	0.95±0.20	0.75±0.10	25	MFE200VJ	
25.0	13.0	0.95±0.20	0.90±0.10	25	MFE250VJ	
32.0	16.0	0.95±0.20	0.95±0.10	25	MFE320VJ	

Mufte me raport 3/1, SBRSM-NF, super rezistent ndaj ujit, lageshtires dhe demtuesve te tjere

-45 +125

Gjendje normale	Pas tkurrjes			Paketimi	Kodi	Çmimi (lekë/metër)
Diametri Brendshëm	Diametri brendshëm	Trashësia e Veshjes	Trashësia adezivit	Trashësia e murit	Rulon (metër)	
3.2	1.00	1.10±0.10	0.50	1.60±0.10	200	MF00301
4.8	1.50	1.20±0.10	0.50	1.70±0.10	100	MF00502
6.4	2.00	1.30±0.10	0.50	1.80±0.10	100	MF00602
9.5	3.00	1.70±0.15	0.60	2.30±0.15	50	MF00903
12.0	4.00	2.00±0.20	0.80	2.80±0.20	1.22	MF01204
16.0	5.00	2.20±0.20	0.80	3.00±0.20	1.22	MF01605
19.0	6.00	2.30±0.20	0.80	3.10±0.20	1.22	MF01906
28.0	9.00	2.40±0.20	1.05	3.45±0.20	1.22	MF02809
33.0	10.00	2.50±0.20	1.05	3.55±0.20	1.22	MF03310
40.0	12.00	2.50±0.20	1.05	3.55±0.20	1.22	MF04012
44.0	14.00	2.50±0.20	1.05	3.55±0.20	1.22	MF04414
52.0	18.00	2.50±0.20	1.05	3.55±0.20	1.22	MF05218
70.0	25.00	3.00±0.30	1.35	4.35±0.30	1.22	MF07025
90.0	30.00	3.00±0.30	1.35	4.35±0.30	1.22	MF09030
115.0	35.00	3.00±0.30	1.35	4.35±0.30	1.22	MF11535

Kabull klas F, 155°C, LEV 160, pa halogen

Seksioni mm ²	Diametri mm ±0.1	Numri i telave	Tensioni Nominal (V)	Paketimi (metër)	Çmimi (lekë/metër)
0.75	2.4	24x0.20	300/500	300	
1.00	2.5	32x0.20	300/500	300	
1.50	2.8	30x0.25	300/500	300	
2.50	3.4	50x0.25	300/500	200	
4.00	4.2	56x0.30	300/500	100	
6.00	5.2	48x0.40	300/500	100	

GWEST

Emerues teli, mbeshjtjelles spiral, mantel i endur për kabull

Kodi	Percjelles	Gjeresia e Kokes	Çmimi
EC0	1.5-2.5 mm	0	
EC1	1.5-2.5 mm	1	
EC2	1.5-2.5 mm	2	
EC3	1.5-2.5 mm	3	
EC4	1.5-2.5 mm	4	
EC5	1.5-2.5 mm	5	
EC6	1.5-2.5 mm	6	
EC7	1.5-2.5 mm	7	
EC8	1.5-2.5 mm	8	
EC9	1.5-2.5 mm	9	

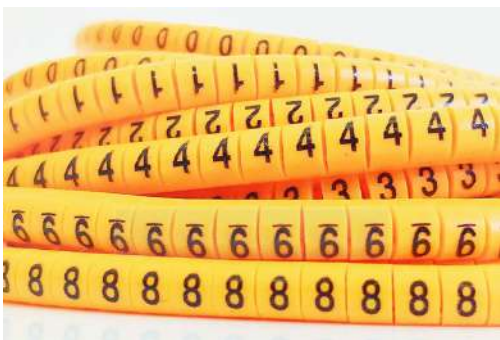
Mantel i endur për kabull

Seksioni Nominal (mm)	Zgjerimi max	Tkurrja min	Paketimi (metër)	Çmimi (lekë/metër)
6	9	3	100	
10	19	7	100	
12	24	8	100	
15	27	10	100	
20	30	14	100	
25	35	18	100	

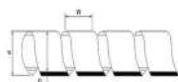

Mbeshjtjelles spiral kabulli

Seksioni Nominal (mm)	O.D. (mm)	W mm	T mm	Paketimi (metër)	Çmimi (lekë/metër)
2.5-15	6	7.4	0.60	10	
6-30	8	12	0.75	10	
7.5-30	10	12.3	0.80	10	
9-32	12	15	0.85	10	
12-35	15	15.5	1.00	10	



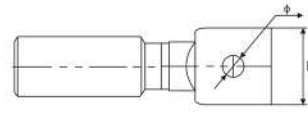
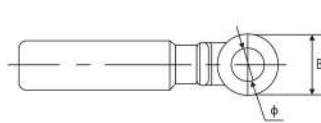
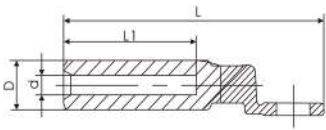

KAPIKORDA & PINCA

Kapikorda industriale ekonomike

Seksioni mm ²	Ø Vrima	d	D	l	L	B	Kodi	Çmimi
16 mm ²	M10	6	16	41	82	24	SKP-BM 16-10	
25 mm ²	M10	7	16	41	82	24	SKP-BM 25-10	
35 mm ²	M10	8.5	16	41	82	24	SKP-BM 35-10	
50 mm ²	M12	9.8	20	49	90	25	SKP-BM 50-12	
70 mm ²	M12	11.6	20	49	90	25	SKP-BM 70-12	
95 mm ²	M12	13.8	20	49	90	25	SKP-BM 95-12	
120 mm ²	M12	15.5	25	60	113	28	SKP-BM 120-	
150 mm ²	M12	17	25	60	113	28	12SKP-BM 150-	
185 mm ²	M12	18.5	32	65	130	35	12SKP-BM 185-	
240 mm ²	M12	21.5	32	65	130	35	12SKP-BM 240-	
300 mm ²	M12	24	34	70.8	135	36	12SKP-BM 300-	
400 mm ²	M16	26	34	70.8	135	36	12SKP-BM 40-16	

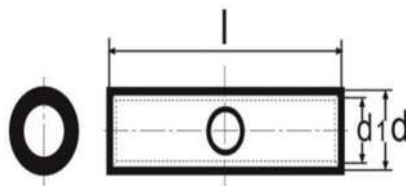
Bashkues kabulli industrial

Seksioni mm ²	D1	D2	L	Kodi	Çmimi
10	4.7	6.6	29	EK100047	
16	5.6	7.8	32	EK160056	
25	7.1	9.5	40.5	EK250071	
35	8.2	10.8	45.5	EK350082	
50	10.0	13.0	53.5	EK500100	
70	11.5	14.7	57.5	EK700115	
95	13.5	16.7	61.5	EK950135	
120	15.6	19.0	74.0	EK120156	
150	16.5	21.0	79.0	EK150165	
185	18.4	23.0	85.0	EK185184	
240	21.0	26.0	94.0	EK240210	

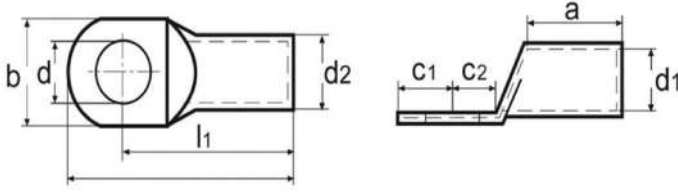

Seksioni mm ²	Ø Vrima	d	d1	d2	l1	C1	a	b	Kodi	Çmimi
10	M5	5.5	4.7	6.0	21.6	6.0	10.0	10.3	SKPS010005	
	M6	6.5	4.7	6.0	21.6	6.0	10.0	10.3	SKPS010006	
	M8	8.5	4.7	6.0	21.6	6.0	10.0	13.5	SKPS010008	
16	M5	5.5	5.6	8.0	25	7.0	12.0	11.2	SKPS016005	
	M6	6.5	5.6	8.0	25	7.0	12.0	11.2	SKPS016006	
	M8	8.5	5.6	8.0	25	7.0	12.0	13.7	SKPS010008	
	M10	10.5	5.6	8.0	25	7.0	12.0	16.0	SKPS010010	
25	M6	6.5	6.8	9.0	32.2	6.8	16.0	13.5	SKPS025006	
	M8	8.5	6.8	9.0	32.2	6.8	16.0	13.5	SKPS025008	
	M10	10.5	7.0	9.5	34.0	6.8	16.0	16.0	SKPS025010	
35	M6	6.5	8.2	10.0	35.7	8.3	19.0	15.7	SKPS035006	
	M8	8.5	8.2	11.0	35.7	8.3	19.0	15.7	SKPS035008	
	M10	10.5	8.2	11.0	38.0	10.0	19.0	15.7	SKPS035010	
	M12	13.0	9.5	12.0	38.0	10.0	19.0	15.7	SKPS035012	
50	M6	6.5	8.2	12.0	39.2	8.3	21.0	17.7	SKPS050008	
	M8	8.5	9.5	12.0	39.2	8.3	21.0	17.7	SKPS050008	
	M10	10.5	9.5	12.0	41.5	10.0	21.0	17.7	SKPS050010	
	M12	13.0	10.1	13.0	41.5	10.0	21.0	19.0	SKPS050012	
	M14	15.0	10.1	13.0	44.5	12.0	21.0	20.5	SKPS050014	
70	M8	8.5	11.2	14.5	44.6	10.0	23.0	21.1	SKPS070008	
	M10	10.5	11.2	14.5	44.6	10.0	23.0	21.1	SKPS070010	
	M12	13.0	11.2	14.5	44.6	10.0	23.0	21.1	SKPS070012	
	M14	15.0	11.2	14.5	47.6	15.0	23.0	21.5	SKPS070014	
	M16	17.0	11.2	14.5	47.6	15.0	23.0	21.5	SKPS070016	
95	M8	8.5	13.4	17.0	48.8	10.0	26.0	24.5	SKPS095008	
	M10	10.5	13.4	17.0	48.8	10.0	26.0	24.5	SKPS095010	
	M12	13.0	13.4	17.0	48.8	10.0	26.0	24.5	SKPS095012	
120	M10	10.5	15.5	19.0	56.0	13.0	29.0	27.7	SKPS120010	
	M12	13.0	15.5	19.0	56.0	13.0	29.0	27.7	SKPS120012	
	M14	15.0	15.5	19.0	56.0	13.0	29.0	27.7	SKPS120014	
	M16	17.0	15.5	19.0	56.0	13.0	29.0	27.7	SKPS120016	
150	M10	10.5	16.5	21.0	60.0	16.5	30.0	30.4	SKPS150010	
	M12	13.0	16.5	21.0	60.0	16.5	30.0	30.4	SKPS150012	
	M14	15.0	16.5	21.0	60.0	16.5	30.0	30.4	SKPS150014	
	M16	17.0	16.5	21.0	60.0	16.5	30.0	30.4	SKPS150016	
185	M10	10.5	16.5	21.0	65.5	16.5	33.0	34.2	SKPS185010	
	M12	13.0	18.5	23.0	65.5	17.0	33.0	34.2	SKPS185012	
	M14	15.0	18.5	23.0	65.5	17.0	33.0	34.2	SKPS185014	
	M16	17.0	18.5	23.0	65.5	17.0	33.0	34.2	SKPS185016	
240	M10	10.5	21	26.0	72.0	17.0	38.0	38.7	SKPS240010	
	M12	13.0	21	26.0	72.0	17.0	38.0	38.7	SKPS240012	
	M14	15.0	21	26.0	72.0	17.0	38.0	38.7	SKPS240014	
	M16	17.0	21	26.0	72.0	17.0	38.0	38.7	SKPS240016	

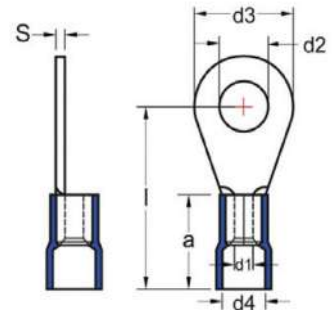
Kapikorda unazë me veshje

Ngjyra	Seksioni mm ²	Ø Vrima	D3	L	D4	A	Paketimi	Kodi	Çmimi
●	0.5-1.5	4	4.3	17	4.0	10.0	200	GYU-401	
●	0.5-1.5	5	5.3	18	4.0	10.0	200	GYU-501	
●	0.5-1.5	6	6.5	18	4.0	10.0	200	GYU-601	
●	0.5-1.5	8	8.4	22	4.0	10.0	200	GYU-801	
●	1.5-2.5	4	4.3	17	4.5	10.0	200	GYU-402	
●	1.5-2.5	5	5.3	19	4.5	10.0	200	GYU-502	
●	1.5-2.5	6	6.5	21	4.5	10.0	200	GYU-602	
●	1.5-2.5	8	8.4	22	4.5	10.0	100	GYU-802	
●	4.0-6.0	5	5.3	21	6.3	13.0	100	GYU-506	
●	4.0-6.0	6	6.5	23	6.3	13.0	100	GYU-606	
●	4.0-6.0	8	8.4	26	6.3	13.0	100	GYU-806	
●	4.0-6.0	10	10.5	28	6.3	13.0	100	GYU-1006	
●	4.0-6.0	12	13.0	28	6.3	13.0	100	GYU-1206	

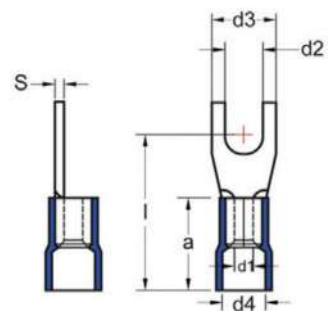
Kapikorda pirun me veshje

Ngjyra	Seksioni mm ²	Ø Vrima	D3	L	D4	A	Paketimi	Kodi	Çmimi
●	0.5-1.5	4	4.3	17	4.0	10.0	200	GCU-401	
●	0.5-1.5	5	5.3	18	4.0	10.0	200	GCU-501	
●	0.5-1.5	6	6.5	18	4.0	10.0	200	GCU-601	
●	1.5-2.5	5	5.3	19	4.5	10.0	200	GCU-502	
●	1.5-2.5	6	6.5	21	4.5	10.0	200	GCU-602	
●	1.5-2.5	8	8.4	22	4.5	10.0	200	GCU-802	
●	4.0-6.0	5	5.3	21	6.3	13.0	100	GCU-506	
●	4.0-6.0	6	6.5	23	6.3	13.0	100	GCU-606	
●	4.0-6.0	8	8.4	26	6.3	13.0	100	GCU-806	

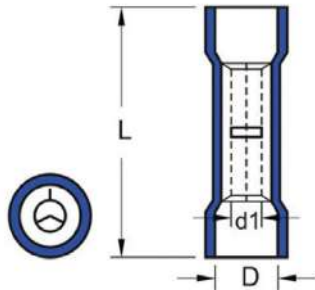
Bashkues kabulli me veshje

Ngjyra	Seksioni mm ²	D	L	D1	Paketimi	Kodi	Çmimi
●	0.5-1.5	4.3	24.6	1.7	200	GBY-251	
●	1.5-2.5	5.3	24.6	2.3	200	GBY-252	
●	4.0-6.0	6.5	26.5	3.4	100	GBY-256	

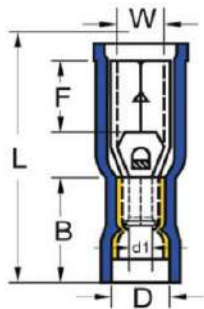
Kapikorda femer kapuç me veshje

Ngjyra	Seksioni mm ²	W	F	L	B	D	Paketimi	Kodi	Çmimi
●	0.5-1.5	3.9	7	23.3	10.5	3.8	200	GBD-1040	
●	1.5-2.5	4.9	7	23.3	10.5	4.7	100	GBD-2050	
●	4.0-6.0	4.9	7	25.1	12.5	6.2	100	GBD-5050	

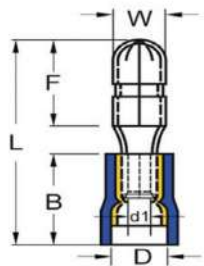
Kapikorda mashkull kapuç me veshje

Ngjyra	Seksioni mm ²	W	F	L	B	D	Paketimi	Kodi	Çmimi
●	0.5-1.5	4.0	8.5	21.5	10.5	3.8	200	GBE-1040	
●	1.5-2.5	5.0	8.5	21.3	10.5	4.7	200	GBE-2050	
●	4.0-6.0	5.0	8.5	24.0	13.0	6.2	200	GBE-5050	

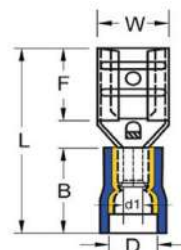
Kapikorda femër me veshje

Ngjyra	Seksioni mm ²	Dimensioni	W	F	L	B	D	Paketimi	Kodi	Çmimi
●	0.5-1.5	0.8 X 2.8	3.2	6.5	19.0	10.5	3.8	200	GFD-1288	
●	0.5-1.5	0.8 X 4.75	5.0	6.4	19.4	10.5	3.8	200	GFD-1488	
●	0.5-1.5	0.8 X 6.35	6.6	7.5	20.8	10.5	3.8	200	GFD-1638	
●	1.5-2.5	0.8 X 2.80	3.2	6.5	19.0	10.5	4.7	200	GFD-2288	
●	1.5-2.5	0.8 X 4.75	5.0	6.4	19.4	10.5	4.7	200	GFD-2488	
●	1.5-2.5	0.8 X 6.35	6.6	7.5	20.8	10.5	4.7	200	GFD-2638	
●	4.0-6.0	0.8 X 6.35	6.6	7.5	23.3	13.0	6.2	200	GFD-5638	

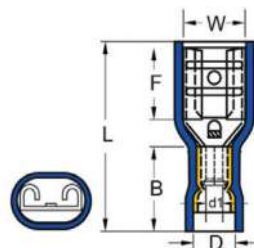
Kapikorda femer me veshje e mbuluar

Ngjyra	Seksioni mm ²	Dimensioni	W	F	L	B	D	Paketimi	Kodi	Çmimi
●	0.5-1.5	0.8 X 2.8	3.2	6.5	19.0	10.5	3.8	200	GFFD-1288	
●	0.5-1.5	0.8 X 4.75	5.0	6.4	20.5	10.5	3.8	200	GFFD-1488	
●	0.5-1.5	0.8 X 6.35	6.6	7.5	21.8	10.5	3.8	200	GFFD-1638	
●	1.5-2.5	0.8 X 2.80	3.2	6.5	20.0	10.5	4.7	200	GFFD-2288	
●	1.5-2.5	0.8 X 4.75	5.0	6.4	20.2	10.5	4.7	200	GFFD-2488	
●	1.5-2.5	0.8 X 6.35	6.6	7.5	22.2	10.5	4.7	200	GFFD-2638	
●	4.0-6.0	0.8 X 6.35	6.6	7.5	24.2	13.0	6.2	200	GFFD-5638	

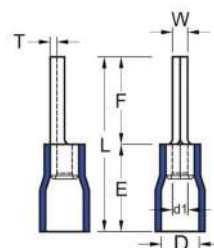
Kapikorda gjilpërë me veshje

Ngjyra	Seksioni mm ²	W	F	L	E	U	Paketimi	Kodi	Çmimi
●	0.5-1.5	1.9	10.0	19.0	10.0	4.0	200	GIK-101	
●	1.5-2.5	1.9	12.0	21.8	10.0	4.5	200	GIK-102	
●	4.0-6.0	2.8	14.0	27.0	10.0	6.4	100	GIK-106	

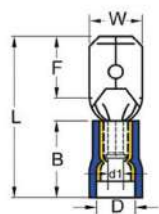
Kapikorda mashkull me veshje

Ngjyra	Seksioni mm ²	Dimensioni	W	F	L	B	D	Paketimi	Kodi	Çmimi
●	0.5-1.5	0.8 X 2.8	2.8	6.5	19.2	10.5	3.8	200	GFE-1288	
●	0.5-1.5	0.8 X 4.75	4.8	6.7	19.8	10.5	3.8	200	GFE-1488	
●	0.5-1.5	0.8 X 6.35	6.35	7.7	21.8	10.5	3.8	200	GFE-1638	
●	1.5-2.5	0.8 X 2.80	2.8	6.7	19.8	10.5	4.7	200	GFE-2288	
●	1.5-2.5	0.8 X 4.75	4.8	6.7	19.8	10.5	4.7	200	GFE-2488	
●	1.5-2.5	0.8 X 6.35	6.35	7.7	21.8	10.5	4.7	200	GFE-2638	
●	4.0-6.0	0.8 X 6.35	6.35	7.7	24.8	13.0	6.2	200	GFE-5638	

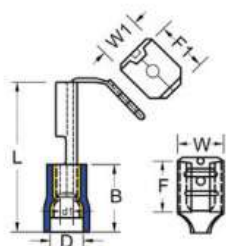
Kapikorda mashkull- femër me veshje

Ngjyra	Seksioni mm ²	Dimensioni	W	F	L	E	D	Paketimi	Kodi	Çmimi
●	0.5-1.5	0.8 x 6.35	6.6	8.0	22.5	10.5	3.8	100	GFDEG-1861	
●	1.5-2.5	0.8 x 6.35	6.6	8.0	22.5	10.5	4.7	100	GFDEG-2862	
●	4.0-6.0	0.8 x 6.35	6.6	8.0	24.0	13.0	6.2	100	GFDEG-5866	

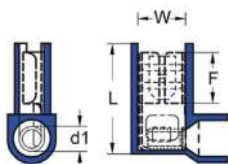
Kapikorda femër këndore temperature

Ngjyra	Seksioni mm ²	Dimensioni	W	F	L	Paketimi	Kodi	Çmimi
●	0.5-1.5	0.8 x 6.35	6.6	7.6	16.0	100	GPFDEB-1861	
●	1.5-2.5	0.8 x 6.35	6.6	7.6	16.0	100	GPFDEB-2862	

Kapikorda kapuç

Ngjyra	A	B	C	D	E	Paketimi	Kodi	Çmimi
●	3.0	7.8	8.0	4.0	20.0	100	HW-C4	
●	3.8	10.5	11.0	4.5	25.3	100	HW-C5	

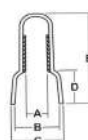

Kapikorda terminale teke

Ngjyra	Seksioni mm ²	F	L	W	B	D	C	Kodi	Çmimi
●	0.50	8.0	14	2.6	6.0	1.3	1.0	IYA-0.50	
	0.75	8.0	14	2.8	6.3	1.5	1.2	IYA-0.75	
●	1.0	8.0	14	3.0	6.3	1.7	1.4	IYA-1.00	
●	1.5	8.0	14	3.5	6.3	2.0	1.7	IYA-1.50	
●	2.5	8.0	14	4.2	7.4	2.5	2.2	IYA-2.50	
●	4.0	10.0	17	4.8	7.4	3.2	2.8	IYA-4.00	
●	6.0	12.0	20	6.3	8.5	3.9	3.5	IYA-6.00	
●	10.0	12.0	22	7.6	8.5	4.9	4.5	IYA-10.0	
●	16.0	12.0	24	8.8	10.0	6.2	5.8	IYA-16.0	
●	25.0	16.0	28	11.2	12.0	7.7	7.3	IYA-25.0	
●	35.0	16.0	30	12.7	14.0	8.7	8.3	IYA-35.0	
●	50.0	20.0	36	15.0	16.0	10.9	10.3	IYA-50.0	

Kapikorda terminale dyshe

Ngjyra	Seksioni mm ²	F	L	W	B	D	C	Kodi	Çmimi
●	2 X 0.50	8.0	14	5.0	6.5	1.8	1.5	CYA-0.50	
	2 X 0.75	8.0	14	5.5	6.7	2.1	1.8	CYA-0.75	
●	2 X 1.00	8.0	14	5.5	7.1	2.4	2.1	CYA-1.00	
●	2 X 1.50	8.0	14	6.4	7.5	2.6	2.3	CYA-1.50	
●	2 X 2.50	10.0	14	8.0	8.5	3.3	2.9	CYA-2.50	
●	2 X 4.00	12.0	17	8.0	11.1	4.2	3.8	CYA-4.00	
●	2 X 6.00	14.0	20	9.5	12.1	5.3	4.9	CYA-6.00	
●	2 X 10.00	14.0	27	12.6	12.6	6.9	6.5	CYA-10.00	
●	2 X 16.00	14.0	31	19.0	17.3	8.7	8.3	CYA-16.00	



Kapikorda unaze pa veshje			
Seksioni mm ²	Vrima	Kodi	Çmimi
1	3	KSZ103	
	4	KSZ104	
	4	KSZ254	
2.5	5	KSZ255	
	6	KSZ256	
4.0	4	KSZ404	
	5	KSZ405	
	6	KSZ406	
6.0	6	KSZ606	
8.0	8	KSZ808	
10.0	10	KSZ1010	



Kapikorda femer pa veshje			
w	Seksioni mm ²	Kodi	Çmimi
2.8	0.25-1.50	KZF028	
4.8	0.50-2.50	KZF048	
6.3	0.50-2.50	KZF063	
	2.50-4.00	KZF163	
9.5	4.00-6.00	KZF095	



Kapuç plastik për kapikorda		
w	Kodi	Çmimi
6.3 x 0.8	KF1D01	



Kapikorda femer këndore			
w	Seksioni mm ²	Kodi	Çmimi
6.3 X 0.8	0.50-2.50	KZK001	



Kapikorda mashkull-femër			
w	Seksioni mm ²	Kodi	Çmimi
6.3 X 0.8	0.50-2.50	KZMF001	



Kapikorda femer këndore			
w	Seksioni mm ²	Kodi	Çmimi
6.3 X 0.8	0.50-2.50	KMZ001	



Mashkull me stopues			
w	Seksioni mm ²	Kodi	Çmimi
6.3 X 0.8	0.50-2.50	KMZS001	

Morseteri					
n°	Përmasa (mm)	Dis. Vrimave (mm)	Bulloni	Kodi	Çmimi
1	40x25	15	Ø 4	MS14025	
2	50x30	20	Ø 4	MS25030	
3	60x37	25	Ø 5	MS36037	
4	73x44	30	Ø 6	MS47344	
5	91x56	35	Ø 8	MS59156	
6	115x70	45	Ø 10	MS611570	
7	150x95	55	Ø 12	MS715095	



GWEST

Pinca për kapikorda dhe gërshërë

 Për kapikorda te veshura 0.50-6.00mm²

 Kodi YYT7
 Çmim

 Për kapikorda pa veshje 0.50-6.00mm²

 Kodi YYT11
 Çmim

 Për kapikorda pa veshje 0.5-6.00mm²

 Kodi YAC6
 Çmim

 Për kapikorda tubolare 0.08-6.00mm²

 Kodi YAC9
 Çmim

 Për kapikorda tubolare 0.08-6.00mm²

 Kodi YAC8
 Çmim

Pince Multifunkionale për kapikorda

 Kodi YYTB4
 Çmim

 Për kapikorda industriale
 5.00-50.00mm²

 Kodi JY0650
 Çmim

 Për kapikorda industriale
 16.00-300.00mm²

 Kodi YQK300
 Çmim

 Pince per prerje kabelli deri 325 mm²

 Kodi TCR- 325
 Çmim



12

BASHKUES KABULLI

Bashkues kabulli

Kabëll	Kanalet	Ngarkesa	Paketimi	Kodi	Çmimi
0.50-2.5mm ²	2	24A	200	GW-2.5/2	
0.50-2.5mm ²	3	24A	200	GW-2.5/3	
0.50-2.5mm ²	4	24A	100	GW-2.5/4	
0.50-2.5mm ²	5	24A	100	GW-2.5/5	
0.50-2.5mm ²	6	24A	100	GW-2.5/6	
0.50-2.5mm ²	8	24A	100	GW-2.5/8	

Bashkues kabulli me kapse



Kabëll	Kanalet	Ngarkesa	Paketimi	Kodi	Çmimi
0.14-4.0mm ²	2	32A/4KW	100	GW-412	
0.14-4.0mm ²	3	32A/4KW	100	GW-413	
0.14-4.0mm ²	4	32A/4KW	50	GW-414	
0.14-4.0mm ²	5	32A/4KW	50	GW-415	

Bashkues kabelli me kapse model WAGO per kabell 0.5-2.5 / 32A/4kW

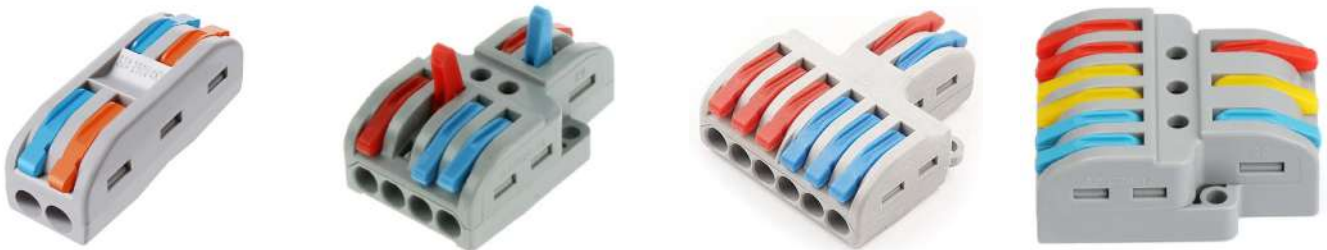

Kabëll	Kanalet	Ngarkesa	Paketimi	Kodi	Çmimi
0.14-2.5mm ²	2	32A /4KW	100	222-102	
0.14-2.5mm ²	3	32A /4KW	100	222-102	
0.14-2.5mm ²	4	32A /4KW	50	222-102	
0.14-2.5mm ²	5	32A /4KW	50	222-102	

Bashkues teli model WAGO 1p / 2p/ 3p me ngarkese 32A/4kW

Kabëll	Kanalet	Ngarkesa	Paketimi	Kodi	Çmimi
0.2-4.0mm ²	1+1	32A /4KW	60	222-221	
0.2-4.0mm ²	2+2	32A /4KW	30	222-222	
0.2-4.0mm ²	2+2	32A /4KW	30	222-222T	
0.2-4.0mm ²	3+3	32A /4KW	24	222-223	

Bashkues teli model WAGO 2-4p / 2-6p/ 3-6p/3+9p me ngarkese 32A/4kW

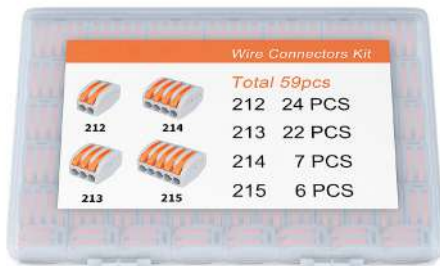
Kabëll	Kanalet	Ngarkesa	Paketimi	Kodi	Çmimi
0.2-4.0mm ²	2+4	32A /4KW	10	222-242	
0.2-4.0mm ²	2+6	32A /4KW	10	222-623	
0.2-4.0mm ²	3+6	32A /4KW	10	222-633	
0.2-4.0mm ²	3+9	32A /4KW	10	222-933	

Kuti shperndarese 1 polare

Kodi PCT-59
Çmimi



Kodi	Volt	Amper	Çmimi
X3-03A	400V	3A	
X3-06A	400V	6A	
X310A	400V	10A	
X316A	400V	16A	
X3-20A	400V	20A	
X3-30A	400V	30A	
X3-60A	400V	60A	

Morseteri shperndarese

Kodi	Ngarkesa	Përcjellësi ne hyrje	Përcjellësi ne dalje	Çmimi
GW-80A	80A	1 x 10-16 mm	4 x 2,5-6 mm ² 2 x 2,5-16 mm ²	
GW-125A	125A	1 x 10-35 mm	6 x 2,5-16 mm ² 1 x 6-16 mm ²	
GW-160A	160A	1 x 10-70 mm	6 x 2,5-16 mm ² 1 x 6-16 mm ²	

Kuti shperndarese 2 polare

Kodi	Ngarkesa	Përcjellësi ne hyrje	Përcjellësi ne dalje	Çmimi
GW-2X7	125A	1 x 10-35 mm	1x10-25 mm ² 5x2,5-6 mm ²	
GW-2X11	125A	2 x 10-35 mm	2x10-25 mm ² 7x2,5-6 mm ²	
GW-2X15	125A	1 x 10-70 mm	2x10-25 mm ² 11x2,5-6 mm ²	

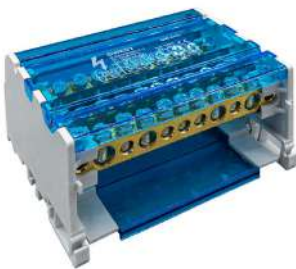
Kuti shperndarese 4 polare

Kodi	Ngarkesa	Percjellsi ne hyrje	Percjellësi ne dalje	Çmimi
GW-4X7	125A	1 x 10-35 mm	1x10-25 mm ² 5x2,5-6 mm ²	
GW-4X11	125A	2 x 10-35 mm	2x10-25 mm ² 7x2,5-6 mm ²	
GW-4X15	125A	1 x 10-70 mm	2x10-25 mm ² 11x2,5-6 mm ²	

Kuti shperndarese 3-4 polare

Kodi	Ngarkesa	Pole	Diametri			Çmimi
			L1	B	G	
TC-603	60A	3	86.5	42.7	M6	
TC-604	60A	4	115	42.7	M6	
TC-1003	100A	3	113.5	55.2	M6	
TC-1004	100A	4	137.5	55.2	M6	

Morseteri sferndarese

Kodi	Voltazhi	Përcjellësi	Çmimi
ITC-101-2AWG	600 V	2.5-35 mm ²	
ITC-101-2/0AWG	600 V	16-70 mm ²	



Morseteri sferndarese

Kodi	Voltazhi	Përcjellësi	Çmimi
ITC-102D-2AWG	600 V	2.5-25 mm ²	
ITC-102D-2/0AWG	600 V	16-70 mm ²	
ITC-102D-4/0AWG	600 V	16-120 mm ²	



Morseteri sferndarese

Kodi	Voltazhi	Përcjellësi	Çmimi
ITC-102-4AWG	600 V	2.5-25 mm ²	



Morseteri sferndarese

Kodi	Voltazhi	Percielli	Çmimi
ITC-103-4AWG	600 V	2.5-35 mm ²	



CNC

Shtrengues për kabull 3-32 mm²



A: Lock Nut

C: Body

E: Sealing Nut

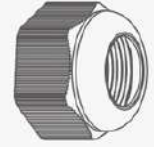
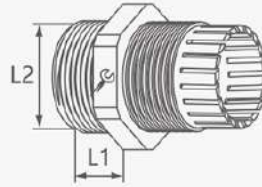

B: Washer

D: Seal

Kodi	Kabulli (mm)	Fija O.D. L2 (mm)	Gjatësia e fijos L1 (mm)	Madhësia e çelësit A&E	Çmimi
CNC-PG7	3-6.5	12.5	9	18/16	
CNC-PG9	4-8	15.2	9	22/19	
CNC-PG11	5-10	18.6	9	24/22	
CNC-PG13.5	6-11	20.4	10	27/24	
CNC-PG16	10-13	22.5	10	30/27	
CNC-PG19	12-15	24	10	30/28	
CNC-PG21	13-18	28.3	12	35/33	
CNC-PG25	16-21	30	12	37/35	
CNC-PG29	18-25	37	12	45/42	
CNC-PG36	22-32	47	15	58/52	



CEMBRE

Shtrengues Kabelli 3-32 mm²

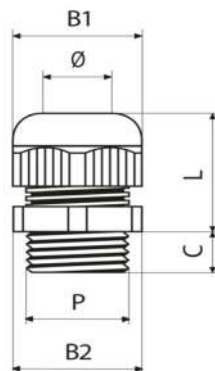

Kodi	P	B1 mm	B2 mm	L mm	C mm	Çmimi
CEM-PG9	15.5	19	19	22÷26	8	
CEM-PG11	18.8	22	22	23÷28	8	
CEM-PG13.5	20.5	24	24	24÷29	9	
CEM-PG16	22.6	27	27	26÷31	10	
CEM-PG21	28.5	33	33	30÷35	12	
CEM-PG29	37.2	42	42	33÷39	12	
CEM-PG36	47.2	53	53	42÷49	14	

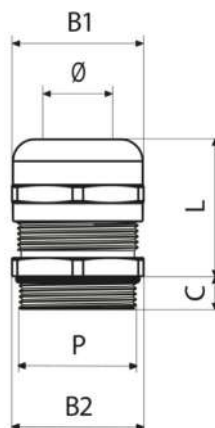

Kodi	P	B1 mm	B2 mm	L mm	C mm	Çmimi
M-PG9	15.5	17	17	17÷23	6	
M-PG11	18.8	20	20	20÷25	6	
M-PG13.5	20.5	22	22	20÷26	6.5	
M-PG16	22.6	24	24	20÷27	6.5	
M-PG21	28.5	30	30	24÷30	7	
M-PG29	37.2	40	40	30÷37	8	
M-PG36	47.2	50	50	38÷48	8	



















Morseteri modulare (Terminal Connector)

CNC

Kodi	Ngjyra	Seksioni	Seksion Nominal	Amper	Voltazhi	Çmimi
UK-1.5N	Gri	0.14-1.5 mm	1.5 mm ²	17.5A	500 V	 UK
UK-3N	Gri	0.2-4 mm	2.5 mm ²	24 A	800 V	
UK-5N	Gri	0.2-6 mm	4 mm ²	32 A	800 V	
UK-6N	Gri	0.2-10 mm	6 mm ²	41 A	800 V	
UK-10N	Gri	0.5-16 mm	10 mm ²	57 A	800 V	
UK-16N	Gri	0.5-16 mm	16 mm ²	76 A	800 V	
Kodi	Ngjyra	Seksioni	Seksion Nominal	Amper	Voltazhi	Çmimi
USLKG5		0.2-6 mm ²	4 mm ²	32 A	690 V	 USLKG
USLKG6N		0.2-10 mm ²	6 mm ²	41 A	690 V	
USLKG10N		0.2-10 mm ²	10 mm ²	57A	690 V	
USLKG16N		0.5-16 mm ²	16 mm ²	76 A	690 V	
Permasat	Kodi	Çmimi				
36-2-50 mm	UK baffle		 UK baffle			

Morseteri modulare (Terminal Connector)



Kodi	Ngjyra	Seksioni	Seksion Nominal	Amper	Voltazhi	Çmimi	
PH3001501		0.2-4 mm ²	2.5 mm ²	24A	800 V		
PH3001514		0.2-4 mm ²	2.5 mm ²	24 A	800 V		
PH3004362		0.2-6 mm ²	4 mm ²	32 A	800 V		
PH3004388		0.2-6 mm ²	4 mm ²	32 A	800 V		
PH3004524		0.2-10 mm ²	6 mm ²	41 A	800 V		
PH3004977		0.2-10 mm ²	6 mm ²	41 A	800 V		
PH3005073		0.5-16 mm ²	10 mm ²	57 A	800 V		
PH3005086		0.5-16 mm ²	10 mm ²	57 A	800 V		
PH3006043		2.5-25 mm ²	16 mm ²	76 A	800 V		
PH3006056		2.5-25 mm ²	16 mm ²	76 A	800 V		
Kodi	Ngjyra	Seksioni	Seksion Nominal	Amper	Voltazhi	Çmimi	
PH0441504		0.2-6 mm ²	4 mm ²	32 A	690 V		
PH0442079		0.2-10 mm ²	6 mm ²	41 A	690 V		
PH3003923		0.2-10 mm ²	10 mm ²	57A	690 V		
PH0443023		0.5-16 mm ²	16 mm ²	76 A	690 V		
Permasat	Kodi	Çmimi	Permasat	Kodi	Çmimi		
39-1.8-42.5 mm	PH3003020		36-2-50 mm	PH1923034			

Bashkues kabulli 3x16A (2P+E) IP44

Pozicioni	Lloji	Tensioni	Kodi	Çmimi
SPINE	MASHKULL	220/240V AC	ECE316V4FU	
BRENDA MURIT	FEMER	220/240V AC	ECE316V4PE	
JASHT MURIT	FEMER	220/240V AC	ECE316V4PM	
SHUKO	FEMER	220/240V AC	ECE316V4PU	

Bashkues kabulli 3x16A (3P+E) IP44

Pozicioni	Lloji	Tensioni	Kodi	Çmimi
SPINE	MASHKULL	220/240V AC	ECE416V5FU	
BRENDA MURIT	FEMER	220/240V AC	ECE416V5PE	
JASHT MURIT	FEMER	220/240V AC	ECE416V5PM	
SHUKO	FEMER	220/240V AC	ECE416V5PU	

Bashkues kabulli 3x16A (3P+N-E) IP44

Pozicioni	Lloji	Tensioni	Kodi	Çmimi
SPINE	MASHKULL	220/240V AC	ECE532V6FU	
BRENDA MURIT	FEMER	220/240V AC	ECE532V6PE	
JASHT MURIT	FEMER	220/240V AC	ECE532V6PM	
SHUKO	FEMER	220/240V AC	ECE532V6PU	

Bashkues kabulli 5x32A (3P+N-E) IP44

Pozicioni	Lloji	Tensioni	Kodi	Çmimi
SPINE	MASHKULL	200/415V AC	9415	
BRENDA MURIT	FEMER	200/415V AC	6006Q	
JASHT MURIT	FEMER	200/415V AC	2517	
SHUKO	FEMER	200/415V AC	9525	

Bashkues kabulli 5x32A (3P+N-E) IP67

Pozicioni	Lloji	Tensioni	Kodi	Çmimi
SPINE	MASHKULL	200/415V AC	8415	
BRENDA MURIT	FEMER	200/415V AC	7006Q	
JASHT MURIT	FEMER	200/415V AC	2567	
SHUKO	FEMER	200/415V AC	8525	

Bashkues kabulli 5x16/32/63A (3P+N+NE) IP44

Fuqia	Lloji	Lloji	Tensioni	Kodi	Çmimi
16A	SPINE	MASHKULL	400V	P01156	
32A	SPINE	MASHKULL	400V	P01256	
63A	SPINE	MASHKULL	400V	P01356	
16A	BRENDA MURIT	FEMER	400V	S11156	
32A	BRENDA MURIT	FEMER	400V	S11256	
63A	BRENDA MURIT	FEMER	400V	S06356	
16A	JASHT MURIT	FEMER	400V	PS1-656	
32A	JASHT MURIT	FEMER	400V	PS1-556	
16A	SPINE	FEMER	400V	S01156	
32A	SPINE	FEMER	400V	S01256	
63A	SPINE	FEMER	400V	S01356	

Bashkues kabulli 5x16/32/63A (3P+N+NE) IP67

Fuqia	Lloji	Lloji	Tensioni	Kodi	Çmimi
16A	SPINE	MASHKULL	400V	P02156	
32A	SPINE	MASHKULL	400V	P02256	
63A	SPINE	MASHKULL	400V	P563E-1	
16A	BRENDA MURIT	FEMER	400V	S07156	
32A	BRENDA MURIT	FEMER	400V	S07256	
63A	BRENDA MURIT	FEMER	400V	S07356	
16A	JASHT MURIT	FEMER	400V	PS2-65	
32A	JASHT MURIT	FEMER	400V	PS2-55	
16A	SPINE	FEMER	400V	S02156	
32A	SPINE	FEMER	400V	S02256	
63A	SPINE	FEMER	400V	S563E-1	

Kuti

Fuqia	Lloji	Tensioni	Kodi	Çmimi
16A	Automat+Celes	400V	ZH1R-W56	
32A	Automat+Celes	400V	ZH2R-W56	
16A	Celes	400V	ZH1K-W56	
32A	Celes	400V	ZH2K-W56	
63A	Celes	400V	ZH3K-W56	
16A	Automat	400V	ZH1R-W56	
32A	Automat	400V	ZH2R-W56	

Kuti

Fuqia	Lloji	Tensioni	Kodi	Çmimi
16A	Celes IP44	400V	ZH1H-S56	
32A	Celes IP44	400V	ZH2H-S56	
63A	Celes IP44	400V	ZH3H-S56	
16A	Celes IP67	400V	ZH1H-W56	
32A	Celes IP67	400V	ZH2H-W56	
63A	Celes IP67	400V	ZH3H-W56	



Bashkues kabulli 4-5 polare 16A

EBM04FU30



EBM04FU10



EBM04PM46



EBM05FU30



EBM05PE46



EBM05PM46

Hyrje	Lloji	Kodi	Çmimi
ANSORE	MASHKULL	EBM04FU10	
LART	MASHKULL	EBM04FU30	
MURALE	MASHKULL	EBM04FE41	
MURALE	MASHKULL	EBM04FE46	
ANSORE	FEMER	EBM04PU10	
LART	FEMER	EBM04PU30	
LART	FEMER	EBM04PU36	
MURALE	FEMER	EBM04PM46	
MURALE	FEMER	EBM04PE41	
MURALE	FEMER	EBM04PE46	
ANSORE	MASHKULL	EBM05FU10	
LART	MASHKULL	EBM05FU30	
MURALE	MASHKULL	EBM05FE41	
MURALE	MASHKULL	EBM05FE46	
ANSORE	FEMER	EBM05PU10	
LART	FEMER	EBM05PU30	
MURALE	FEMER	EBM05PE46	
LART	FEMER	EBM05PM46	

Bashkues kabulli 6 polare 16A

EBM06FU30



EBM06FM42



EBM06PM46



EBM06PU30

Hyrje	Lloji	Kodi	Çmimi
ANSORE	MASHKULL	EBM06FD12	
MURALE	MASHKULL	EBM06FM42	
ANSORE	MASHKULL	EBM06FU10	
LART	MASHKULL	EBM06FU30	
ANSORE	FEMER	EBM06FD12	
MURALE	FEMER	EBM06PM42	
MURALE	FEMER	EBM06PM46	
LART	FEMER	EBM06PU10	
LART	FEMER	EBM06PU30	
LART	FEMER	EBM06PU32	

Bashkues kabulli 10 polare 16A

EBM10FD24



EBM10FU10



EBM10PU10



EBM10PM44

Hyrje	Lloji	Kodi	Çmimi
ANSORE	MASHKULL	EBM10FD14	
ANSORE	MASHKULL	EBM10FD24	
MURALE	MASHKULL	EBM10FM44	
ANSORE	MASHKULL	EBM10FU10	
LART	MASHKULL	EBM10FU30	
ANSORE	FEMER	EBM10PD14	
ANSORE	FEMER	EBM10PD24	
MURALE	FEMER	EBM10PM44	
ANSORE	FEMER	EBM10PU10	
LART	FEMER	EBM10PU30	

Bashkues kabulli 16 polare, 16A

Hyrje	Lloji	Kodi	Çmimi
ANSORE	MASHKULL	EBM16FD14	
ANSORE	MASHKULL	EBM16FD24	
MURALE	MASHKULL	EBM16FM44	
ANSORE	MASHKULL	EBM16FU10	
LART	MASHKULL	EBM16FU30	
ANSORE	FEMER	EBM16PD14	
ANSORE	FEMER	EBM16PD24	
MURALE	FEMER	EBM16FM44	
ANSORE	FEMER	EBM16PU10	
LART	FEMER	EBM16PU14	
LART	FEMER	EBM16PU30	



EBM16FM44



EBM16FU10



EBM16PU10



EBM16PD14

Bashkues kabulli, 24 polare, 16A

Hyrje	Lloji	Kodi	Çmimi
ANSORE	MASHKULL	EBM24FD14	
ANSORE	MASHKULL	EBM24FD24	
MURALE	MASHKULL	EBM24FM44	
ANSORE	MASHKULL	EBM24FU10	
ANSORE	FEMER	EBM24PD14	
ANSORE	FEMER	EBM24PD24	
MURALE	FEMER	EBM24PM44	
ANSORE	FEMER	EBM24PU10	
LART	FEMER	EBM24PU14	
LART	FEMER	EBM06PU34	



EBM24FU10



EBM24FD24



EBM24PM44



EBM24PU10

Bashkues kabulli, 32 polare, 16A

Hyrje	Lloji	Kodi	Çmimi
MURALE	MASHKULL	EBM32FM44	
ANSORE	MASHKULL	EBM32FU10	
LART	MASHKULL	EBM32FU30	
ANSORE	FEMER	EBM32PD14	
ANSORE	FEMER	EBM32PD24	
MURALE	FEMER	EBM32PM48	
MURALE	FEMER	EBM32PM44	
ANSORE	FEMER	EBM32PU10	
ANSORE	FEMER	EBM32PU14	
LART	FEMER	EBM32PU30	



EBM32FM44



EBM32FU10



EBM32PM48



EBM32PU10

Tapa per bashkues 4-5-6-10-16 dhe 32 polar

Lloji	Kodi	Çmimi
4-5 Polar	EBA05TK	
6-Polar	EBA06TK	
10-Polar	EBA10TK	
16-Polar	EBA16TK	
24-Polar	EBA24TK	
32- Polar	EBA32TK	



Bashkues kabulli, 6 polare, 35A

Hyrje	Lloji	Kodi	Çmimi
ANSORE	MASHKULL	EBM606FD14	
ANSORE	MASHKULL	EBM606FD24	
MURALE	MASHKULL	EBM606FM44	
ANSORE	MASHKULL	EBM606FU10	
LART	MASHKULL	EBM606FU30	
ANSORE	FEMER	EBM606PD14	
ANSORE	FEMER	EBM606PD24	
MURALE	FEMER	EBM606PM44	
MURALE	FEMER	EBM606PM47	
ANSORE	FEMER	EBM606PU10	
ANSORE	FEMER	EBM606PU30	
LART	FEMER	EBM606PU34	

Bashkues kabulli, 6 polare, 35A

Hyrje	Lloji	Kodi	Çmimi
ANSORE	MASHKULL	EBM612FD14	
ANSORE	MASHKULL	EBM612FD24	
MURALE	MASHKULL	EBM612FM44	
ANSORE	MASHKULL	EBM612FU10	
LART	MASHKULL	EBM612FU30	
ANSORE	FEMER	EBM612PD14	
MURALE	FEMER	EBM612PD24	
MURALE	FEMER	EBM612PM44	
MURALE	FEMER	EBM612PM48	
ANSORE	FEMER	EBM612PU10	
LART	FEMER	EBM612PU30	

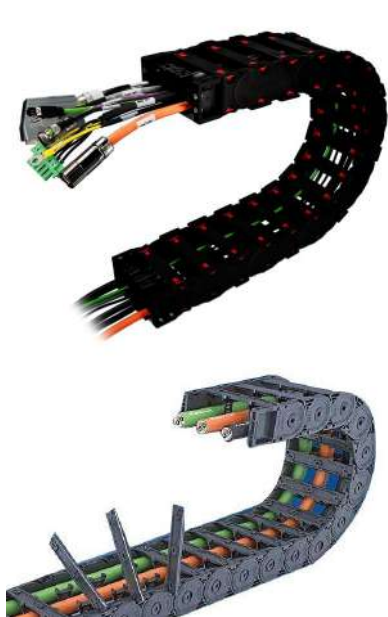
Trasportues kabulli

Kodi	Çmimi
HKP015015ZDA	
HKP015015ZEA	
HKP015015ZKA	
HKP020025ZDA	
HKP020025ZEA	
HKP020025ZKA	
HKP040060ZDA	
HKP040060ZEA	
HKP040060ZKA	
HKP040060Z5A	

Lartësia brenda	Gjerësia brenda	Rrezja Lakuese	Gjatësia	Kodi	Çmimi
15	15	25	100 CM	HKP015015R1A	
25	25	40	100 CM	HKP020025R3A	
40	60	60	100 CM	HKP040060R5A	

13

AKSESORË PËR VINÇA



Pulte kontrolli për vinç me një shpejtësi me 2-4-6 dhe 8 butona

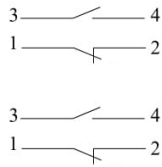

Lloji	Butona	Kodi	Çmimi
1 shpejtësi	2	PV3T12	
	4	PV5T122	
	6	PV7T1222	
	8	PV9T12222	

Pulte kontrolli për vinç me dy shpejtësi me 2-4-6 dhe 8 butona



Lloji	Butona	Kodi	Çmimi
2 shpejtësi	2	PV3T14	
	4	PV5T144	
	6	PV7T1444	
	8	PV9T14444	

Pulte kontrolli për vinç me një shpejtësi dhe buton stopi, me 2-4-6 dhe 8 butona

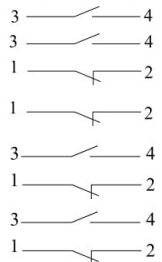

Lloji	Butona	Kodi	Çmimi
1 shpejtësi	2+Emergjencë	PV3E30B2	
	4+Emergjencë	PV5E30B22	
	6+Emergjencë	PV7E30B222	
	8+Emergjencë	PV9E30B2222	

Pulte kontrolli për vinç me dy shpejtësi dhe buton stopi, me 2-4-6 dhe 8 butona

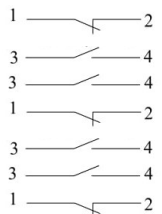

Lloji	Butona	Kodi	Çmimi
2 shpejtësi	2+Emergjencë	PV3E30B4	
	4+Emergjencë	PV5E30B44	
	6+Emergjencë	PV7E30B444	
	8+Emergjencë	PV9E30B4444	

Pulte kontrolli për vinç me një shpejtësi trefazore deri në 2.5kW

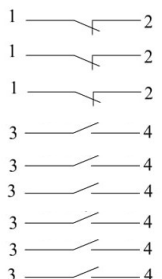

Lloji	Butona	Kodi	Çmimi
3 FAZOR	2+Emergjencë	P03.3	
	4+Emergjencë	P03.5	
	6+Emergjencë	P03.7	
	8+Emergjencë	P03.9	

Kontakte pultesh dhe butona pultesh



Kodi PVB1
Çmimi



Kodi PVTHBD
Çmimi



Kodi PVTHSD
Çmimi



Kodi PVB1
Çmimi



Kodi PVCHBD
Çmimi



Kodi PVCHSD
Çmimi

Pulte kontrolli për vinç



Kodi COB61
Çmimi



COB62



COB63



COB64

Pulte kontrolli për vinç



Kodi COB-C1
Çmimi



COB-C2



COB-C3

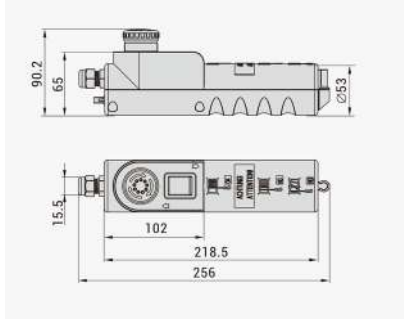

COB-C2

Buton switch HD 30A/250V - IP65

Kodi	HD-01 (147101)
UI	690V
Ith	16A
AC-15	400V 8A 250V 10A 400V 12A 250V 16A
AC-1	250V 16A
DC-13	24V 2A
Çmimi	

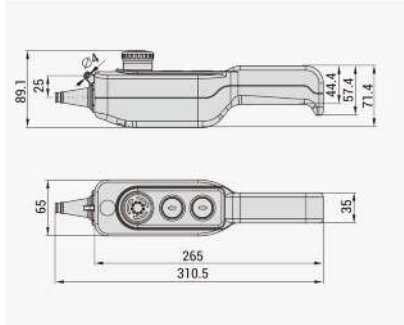
Buton switch HD 5E4 - IP44

Kodi	HD-02 (147203)
AC-15	400V 8A 250V 10A 400V 12A 250V 16A
AC-1	250V 16A
DC-13	24V 2A
Çmimi	

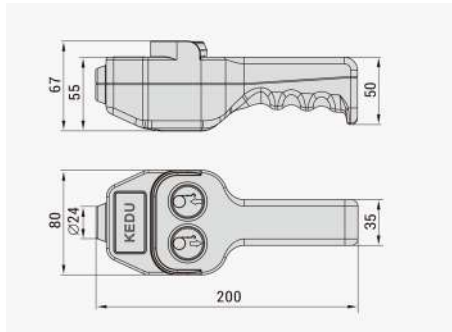
Me inverter faze

Kodi	HD-03 (147301)
Amper	150A
Voltazh	12V DC
Lloji	(ON)-OFF(ON)
Çmimi	

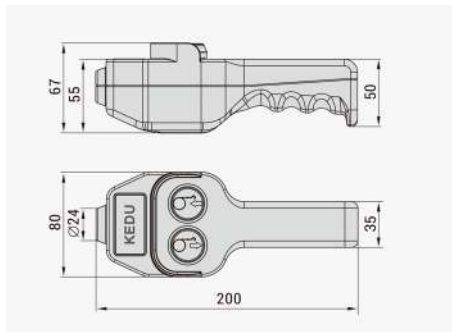
Buton switch HD 5E4 - IP44

Kodi	HD-05 (147501)
AC-15	400V 8A 250V 10A 400V 12A 250V 16A
AC-1	250V 16A
DC-13	24V 2A
Çmimi	

Çelësa fundorë kryq, metalikë

-90°	0°	+90°

-180°	-90°	0°	+90°	+180°

Butona	Kodi	Çmimi
1 hap para, 1 hap pas	CSM02	
2 hapa para, 2 hapa pas	CSM04	
I gjithëanshëm	CSM10	

Çelësa fundorë rrotullues

N° Çelësave	Këndi	Kodi	Çmimi
2	20°	VT2050	
2		VT2100	
2		VT2200	
3		VT3050	
3		VT3100	
3		VT3200	
4		VT4050	
4		VT4100	
4		VT4200	



Elektrofrena 230/400V

A (mm)	B (mm)	Kodi	Çmimi
108	48	MEC56	
122	55	MEC63	
130	57.5	T70	
134	60.5	MEC71	
145	62.5	T80	
155	69	MEC80	
170	72.5	T90	
173	77.5	MEC90	
180	80	T100	
191	85	MEC100	
200	85	T110	
218	100	MEC112	
230	100	T120	
240	105	MEC132	
255	112.5	MEC160	
335	145	MEC180	



GWEST

Pedale komandimi



AP-1



AP-2



AP-3



AP-9

Materiali	Kontakti	Kabell	Ngarkesa	Kodi	Çmimi
Metalike	1 No+1 NC	2 meter	lth-10A	AP-1	
Alumin	1 No+1 NC	1 meter	lth-10A	AP-2	
Alumin	1 No+1 NC	1 meter	lth-10A	AP-3	
Alumin	1 No+1 NC	-	lth-15A	AP-9	

CNC

Pedale komandimi



FS-3



SFMS-1



D8107



YDT1-101

Materiali	Kontakti	Kabell	Ngarkesa	Kodi	Çmimi
Metalike	1 No+1 NC	1 meter	lth-10A	FS-3	
Alumin	1 No+1 NC	-	lth-15A	SFMS-1	
Alumin	2 No+2NC	-	lth-5A/2.5KW	YDT1-101	
Plastik	1 No+1 NC	-	lth-5A/2.5KW	D8107	

EMAS

Pedale komandimi

Pedale kontrolli teke

Materiali	Kontakti	Shpejtesi	Ngarkesa	Kodi	Çmimi
Plastik	1 No+1 NC	1-Shpejtesi	3A/2.5KW	PDNS11BX10	
Plastik	1 No+1 NC	1-Shpejtesi	3A/2.5KW	PDNS11BX11	
Alumin	1 No+1 NC	1-Shpejtesi	3A/2.5KW	PKDS11BX10	
Alumin	2x(1 NO + 1 NC)	1-Shpejtesi	3A/2.5KW	PKDS11GX10*	
Alumin	2*(2NO + 2NC)	2-Shpejtesi	3A/2.5KW	PKDS11GX20*	

Pedale kontrolli dyshe

Materiali	Kontakti	Shpejtesia	Ngarkesa	Kodi	Çmimi
Alumin	(1NO+1NC)+(1NO+1NC)	1-Shpejtesi	3A/2.5KW	PDKA22BB10	
Alumin	(1NO+1NC)+2x(1NO+1NC)	2-Shpejtesi	3A/2.5KW	PDKA22BG20	
Alumin	(1NO+1NC)+(1NO+1NC)	1-Shpejtesi	3A/2.5KW	PDKA22GG10	
Alumin	2x(1NO+1NC)+2x(1NO+1NC)	2-Shpejtesi	3A/2.5KW	PDKA22GG20	

Pedale kontrolli me potesiometer dhe aksesore

Materiali	Kontakti	Shpejtesia	Ngarkesa	Kodi	Çmimi
Alumin	1-CO	Potesiometer	3A/2.5KW	PKDS11PX10	
Metal	-	-	-	PDABE	

14

AUTOMATIKA



LC1D09-12

Bobina	Kapaciteti i fuqisë për AC-3		Ngarkesa		Kontakti ndihmës	Kodi	Çmimi
	220-230V	380-440V	AC-1	AC-3			
24 V	2.2 kW	4 kW	25 A	9 A	1 NO + 1NC	LC1D09B7	
	3 kW	5.5 kW	25 A	12 A		LC1D12B7	
	4 kW	7.5 kW	32 A	18 A		LC1D18B7	
	5.5 kW	11 kW	40 A	25 A		LC1D25B7	
	7.5 kW	15 kW	50 A	32 A		LC1D32B7	
	11 kW	18.5 kW	60 A	40 A		LC1D40AB7	
	15 kW	22 kW	80 A	50 A		LC1D50AB7	
	18.5 kW	30 kW	80 A	65 A		LC1D65AB7	
	22 kW	37 kW	125 A	80 A		LC1D80B7	
	25 kW	45 kW	125 A	95 A		LC1D95B7	



LC1D18-32

Bobina	Kapaciteti i fuqisë për AC-3		Ngarkesa		Kontakti ndihmës	Kodi	Çmimi
	220-230V	380-440V	AC-1	AC-3			
110 V	2.2 kW	4 kW	25 A	9 A	1 NO + 1NC	LC1D09F7	
	3 kW	5.5 kW	25 A	12 A		LC1D12F7	
	4 kW	7.5 kW	32 A	18 A		LC1D18F7	
	5.5 kW	11 kW	40 A	25 A		LC1D25F7	
	7.5 kW	15 kW	50 A	32 A		LC1D32F7	
	11 kW	18.5 kW	60 A	40 A		LC1D40AF7	
	15 kW	22 kW	80 A	50 A		LC1D50AF7	
	18.5 kW	30 kW	80 A	65 A		LC1D65AF7	
	22 kW	37 kW	125 A	80 A		LC1D80F7	
	25 kW	45 kW	125 A	95 A		LC1D95F7	



LC1D40-65

Bobina	Kapaciteti i fuqisë për AC-3		Ngarkesa		Kontakti ndihmës	Kodi	Çmimi
	220-230V	380-440V	AC-1	AC-3			
220 V 230 V	2.2 kW	4 kW	25 A	9 A	1 NO + 1NC	LC1D09M7	
	3 kW	5.5 kW	25 A	12 A		LC1D12M7	
	4 kW	7.5 kW	32 A	18 A		LC1D18M7	
	5.5 kW	11 kW	40 A	25 A		LC1D25M7	
	7.5 kW	15 kW	50 A	32 A		LC1D32M7	
	11 kW	18.5 kW	60 A	40 A		LC1D40AM7	
	15 kW	22 kW	80 A	50 A		LC1D50AM7	
	18.5 kW	30 kW	80 A	65 A		LC1D65AM7	
	22 kW	37 kW	125 A	80 A		LC1D80M7	
	25 kW	45 kW	125 A	95 A		LC1D95M7	



LC1D80-95

Bobina	Kapaciteti i fuqisë për AC-3		Ngarkesa		Kontakti ndihmës	Kodi	Çmimi
	220-230V	380-440V	AC-1	AC-3			
380 V 400 V	2.2 kW	4 kW	25 A	9 A	1 NO + 1NC	LC1D09Q7	
	3 kW	5.5 kW	25 A	12 A		LC1D12Q7	
	4 kW	7.5 kW	32 A	18 A		LC1D18Q7	
	5.5 kW	11 kW	40 A	25 A		LC1D25Q7	
	7.5 kW	15 kW	50 A	32 A		LC1D32Q7	
	11 kW	18.5 kW	60 A	40 A		LC1D40AQ7	
	15 kW	22 kW	80 A	50 A		LC1D50AQ7	
	18.5 kW	30 kW	80 A	65 A		LC1D65AQ7	
	22 kW	37 kW	125 A	80 A		LC1D80Q7	
	25 kW	45 kW	125 A	95 A		LC1D95Q7	

Rele termike për lëshues

Ngarkesa	Kontaktori	Klasi	Frekuenca	Kodi	Çmimi
1.6 - 2.5 A	LC1D09-38	10 A	0-400Hz	LRD07	
2.5 - 4.0 A	LC1D09-38			LRD08	
4.0 - 6.0 A	LC1D09-38			LRD10	
5.5 - 8.0 A	LC1D09-38			LRD12	
7.0 - 10 A	LC1D09-38			LRD14	
9.0 - 13 A	LC1D12-38			LRD16	
16 - 24 A	LC1D25-38			LRD22	
23 - 32 A	LC1D25-38			LRD32	

Rele kohe pneumatik për lëshues

Lloji	Koha	Kontakti	Kodi	Çmimi
Kontakti Ndezës	0.1 - 3 sek	1 NO + 1 NC	LADT0	
	0.1 - 30 sek		LADT2	
	10 - 180 sek		LADT4	
1 - 30 sek	LADS2			
Kontakti Fikës	0.1 - 30 sek	1 NC	LADR0	
	0.1 - 30 sek		LADR2	
	10 - 280 sek		LADR4	

Kontakte ndihmëse për lëshues

Lloji	Koha	Kodi	Çmimi
Kontakti Anësor	1 NO + 1 NC	LADN11	
	2 NO	LADN20	
	2 NO + 2NC	LADN22	
	4 NO	LADN40	

Bobina për lëshues

Tensioni i qarkut	Kontaktori	Rezistenca	Frekuenca	Kodi	Çmimi
24 V	9A - 38A	5.37 Ω	50/60 Hz	LXD1B7	
48 V		21.7 Ω		LXD1E7	
110V		124.1 Ω		LXD1F7	
220V		515.4 Ω		LXD1M7	
380V		1551 Ω		LXD1Q7	
24 V	40A - 65A	1.98 Ω		LXD3B7	
48 V		7.97 Ω		LXD3E7	
110V		42.28 Ω		LXD3F7	
220V		182 Ω		LXD3M7	
380V		512 Ω		LXD3Q7	
24 V	80A - 95A	1.4 Ω	LXD4B5/6		
48 V		5.5 Ω	LXD4E5/6		
110V		31 Ω	LXD4F5/6		
220-230 V		127 Ω	LXD4M5/6		
380-400 V		381 Ω	LXD4Q5/6		



LXD1



LXD3

Mini lëshues 3-polarë, 3NO

Bobina	Kapaciteti i fuqisë për AC-3		Ngarkesa		Kontakti ndihmës	Kodi	Çmimi
	220-230V	380-440V	AC-1	AC-3			
24 V	1.5 kW	2.2 kW	6 A	6 A	1NC	LC1K0601B7 LC1K0901B7 LC1K1201B7 LC1K1601B7	
	2.2 kW	4 kW	20 A	9 A			
	3 kW	5.5 kW	20 A	12 A			
	4 kW	7.5 kW	20 A	16 A			



Bobina	Kapaciteti i fuqisë për AC-3		Ngarkesa		Kontakti ndihmës	Kodi	Çmimi
	220-230V	380-440V	AC-1	AC-3			
48 V	1.5 kW	2.2 kW	6 A	6 A	1NC	LC1K0601E7 LC1K0901E7 LC1K1201E7 LC1K1601E7	
	2.2 kW	4 kW	20 A	9 A			
	3 kW	5.5 kW	20 A	12 A			
	4 kW	7.5 kW	20 A	16 A			

Bobina	Kapaciteti i fuqisë për AC-3		Ngarkesa		Kontakti ndihmës	Kodi	Çmimi
	220-230V	380-440V	AC-1	AC-3			
110 V	1.5 kW	2.2 kW	6 A	6 A	1NC	LC1K0601F7 LC1K0901F7 LC1K1201F7 LC1K1601F7	
	2.2 kW	4 kW	20 A	9 A			
	3 kW	5.5 kW	20 A	12 A			
	4 kW	7.5 kW	20 A	16 A			

Bobina	Kapaciteti i fuqisë për AC-3		Ngarkesa		Kontakti ndihmës	Kodi	Çmimi
	220-230V	380-440V	AC-1	AC-3			
220 V 230 V	1.5 kW	2.2 kW	6 A	6 A	1NC	LC1K0601M7 LC1K0901M7 LC1K1201M7 LC1K1601M7	
	2.2 kW	4 kW	20 A	9 A			
	3 kW	5.5 kW	20 A	12 A			
	4 kW	7.5 kW	20 A	16 A			

Salvamotor

Intervali i rrymës	Kapaciteti i fuqisë për AC-3			Kodi	Çmimi
	400-415V	440V	500V		
1.00-1.60 A	0.55 kW	0.55 kW	0.37-0.75	GV2ME06	
1.60-2.50 A	0.75 kW	0.75-1.1	1.1	GV2ME07	
2.50-4.00 A	1.1-1.5	1.5 kW	1.5-2.2	GV2ME08	
4.00-6.30 A	2.2 kW	2.2-3	3 kW	GV2ME10	
6.00-10.0 A	3-4 kW	4 kW	4-5 kW	GV2ME14	
9.0-14.0 A	7.5 kW	7.5-9	9 kW	GV2ME16	
13.0-18.0	9 kW	11 kW	11 kW	GV2ME20	
A17.0-23.0A	11 kW	15 kW	15 kW	GV2ME21	
24.0-32.0 A	15 kW	37 kW	18.5 kW	GV2ME32	

Rele mbështetëse për lëshues

Qarku i kontrollit të tensionit	Kontakti rryma	Kodi	Çmimi	Kontakti rryma	Kodi	Çmimi
12V AC	2CO - 12A	RXM2AB1J7		4 CO - 6A	RXM4AB2J7	
24V AC		RXM2AB1B7			RXM4AB2B7	
220-230V AC	2CO - 12 A	RXM2AB1P7		4 CO - 6A	RXM4AB2P7	
12V DC		RXM2AB1JD			RXM4AB2JD	
24V DC		RXM2AB1BD			RXM4AB2BD	
220-230V DC					RXM4AB2PD	

Suport dhe modul për rele

Rryma termike konvencionale	Rele	Kodi	Çmimi
10 A	RXM Series	RXZE2M114M	
12 A për 2 CO 6 A për 4 CO	RXM Series	RXZE14P	
10 A për 2 CO 10 A për 3 CO	FI60 Series	FI90 03 SMA	

Automat 6KA, seria civile, EASY9

1P

3P

Ngarkesa	Kodi	Çmimi
16A	EZ9F35116	
20A	EZ9F35120	
25A	EZ9F35125	
32A	EZ9F35132	
40A	EZ9F35140	
50A	EZ9F35150	
63A	EZ9F35163	



Ngarkesa	Kodi	Çmimi
16A	EZ9F35316	
20A	EZ9F35320	
25A	EZ9F35325	
32A	EZ9F35332	
40A	EZ9F35340	
50A	EZ9F35350	
63A	EZ9F35363	



2P

4P

Ngarkesa	Kodi	Çmimi
16A	EZ9F35216	
20A	EZ9F35220	
25A	EZ9F35225	
32A	EZ9F35232	
40A	EZ9F35240	
50A	EZ9F35250	
63A	EZ9F35263	



Ngarkesa	Kodi	Çmimi
16A	EZ9F35416	
20A	EZ9F35420	
25A	EZ9F35425	
32A	EZ9F35432	
40A	EZ9F35440	
50A	EZ9F35450	
63A	EZ9F35463	

Diferencial puro 30MA, seria civile

2P

4P

Ngarkesa	Kodi	Çmimi
25A	EZ9R32225	
40A	EZ9R32240	
63A	EZ9R32263	



Ngarkesa	Kodi	Çmimi
25A	EZ9R32425	
40A	EZ9R32440	
63A	EZ9R32463	



1P+1N

2P+1N

Ngarkesa	Kodi	Çmimi
10A	EZ9P35610	
16A	EZ9P35616	
20A	EZ9P35620	
25A	EZ9P35625	
32A	EZ9P35632	
40A	EZ9P35640	
63A	EZ9P35663	



Ngarkesa	Kodi	Çmimi
10A	A9C2073210	
16A	A9C2073216	
20A	A9C2073220	
25A	A9C2073225	
32A	A9C20732	
40A	A9C2073240	
63A	A9C2073263	



Automate

1P

Ngarkesa	Kodi	Çmimi
16A	A9F74116	
20A	A9F74120	
25A	A9F74125	
32A	A9F74132	
40A	A9F74140	
50A	A9F74150	
63A	A9F74163	
80A	A9N18357	
100A	A9N18358	
125A	A9N18359	



3P

Ngarkesa	Kodi	Çmimi
16A	A9F74316	
20A	A9F74320	
25A	A9F74325	
32A	A9F74332	
40A	A9F74340	
50A	A9F74350	
63A	A9F74363	
80A	A9N18368	
100A	A9N18369	
125A	A9N18370	



2P

Ngarkesa	Kodi	Çmimi
16A	A9F74216	
20A	A9F74220	
25A	A9F74225	
32A	A9F74232	
40A	A9F74240	
50A	A9F74250	
63A	A9F74263	
80A	A9N18361	
100A	A9N18362	
125A	A9N18363	



4P

Ngarkesa	Kodi	Çmimi
16A	A9F74416	
20A	A9F74420	
25A	A9F74425	
32A	A9F74432	
40A	A9F74440	
50A	A9F74450	
63A	A9F74463	
80A	A9N18372	
100A	A9N18374	
125A	A9N18376	

Diferencial 30MA, modul 300ma, IC60

2P

Ngarkesa	Kodi	Çmimi
25A	A9R41225	
40A	A9R41240	
63A	A9R41263	



4P

Ngarkesa	Kodi	Çmimi
25A		
40A	A9R41440	
63A	A9R41463	



2P

Ngarkesa	Kodi	Çmimi
25A	A9R41225	
40A	A9R41240	
63A	A9R41263	

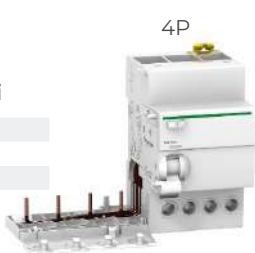

4P

Ngarkesa	Kodi	Çmimi
25A	A9V41425	
40A	A9V41440	
63A	A9V41463	

Thikë qarku, 25KA

Seria	Polar	Ngarkesa	Kodi	Çmimi
Civile	3P	160A	LV516303	
Civile	4P	160A	LV516313	
Industriale	3P	160A	LV430310	
Industriale	4P	160A	LV430330	

Salvomotor, mbrojtje magnetike & termike

Intervali i rrymes	Montimi	Kapaciteti Kalimit (KA)				Kodi	Çmimi
		230 V	400 V	500 V	690 V		
0.63-1.00 A		100	100	100	100	MKSITM-1.0	
1.00-1.60 A		6	6	3	2.5	MKSITM-1.6	
1.60-2.50 A		6	6	3	2.5	MKSITM-2.5	
2.50-4.00 A		6	6	3	2.5	MKSITM-4.0	
4.00-6.30 A	Ne Shine	6	6	2.5	2	MKSITM-6.3	
6.30-10.0 A		6	6	2.5	2	MKSITM-10.0	
10.0-16.0 A		6	6	2.5	2	MKSITM-16	
16.0-20.0 A		6	6	2.5	2	MKSITM-20	
20.0-25.0 A		6	6	2.5	2	MKSITM-25	

Salvomotor me kuti, mbrojtje magnetike & termike

Intervali i rrymes	Montimi	Kapaciteti Kalimit (KA)				Kodi	Çmimi
		230 V	400 V	500 V	690 V		
0.63-1.00 A		100	100	100	100	MKSITMK-1	
1.00-1.60 A		6	6	3	2.5	MKSITMK-1.6	
1.60-2.50 A		6	6	3	2.5	MKSITMK-2.5	
2.50-4.00 A		6	6	3	2.5	MKSITMK-4.0	
4.00-6.30 A	Ne Mure	6	6	2.5	2	MKSITMK-6.3	
6.30-10.0 A		6	6	2.5	2	MKSITMK-10.0	
10.0-16.0 A		6	6	2.5	2	MKSITMK-16	
16.0-20.0 A		6	6	2.5	2	MKSITMK-20	
20.0-25.0 A		6	6	2.5	2	MKSITMK-25	

Kuti për salvamotorë

MKS1-K

Kodi	IZOLIMI	Çmimi
MKS1-K	IP65	
MKS1-KE	IP65	
MKS1-KES	IP65	

MKS1-KES
Kontakte për salvamotorë

Kodi	Kontakti	Çmimi
MKS1-YKD00	2 NC	
MKS1-YKD01	1 No+1 NC	
MKS1-YKD11	2 NO	

Rele nën/mbitension

Kodi	Voltazhi	Çmimi
MKS1-DGR-4	110V 50Hz	
MKS1-DGR-5	220V 50Hz	
MKS1-DGR-6	400V 50Hz	

Shunt rele për salvamotorë

Kodi	Voltazhi	Çmimi
MKS1-AR-2	24V 50Hz	
MKS1-AR-5	220V 50Hz	
MKS1-AR-6	400V 50Hz	

Kontaktor nga 4-7.5KW me bobina 24-48-110-220-380V AC Permasat TH(L) 85.5mm/ GJ(W) 45.5mm /L(H) 74.5mm

Bobina	Kapaciteti i fuqisë për AC-3		Ngarkesa		Kontakti ndihmës	Kodi	Çmimi
	220-230V	380-440V	AC-1	AC-3			
24 V AC	2.2 kW	4 kW	25 A	9 A	1 NO + 1NC	CJX2i-0924	
	3 kW	5.5 kW	25 A	12 A		CJX2i-1224	
	4 kW	7.5 kW	32 A	18 A		CJX2i-1824	
48 V AC	2.2 kW	4 kW	25 A	9 A		CJX2i-0948	
	3 kW	5.5 kW	25 A	12 A		CJX2i-1248	
	4 kW	7.5 kW	32 A	18 A		CJX2i-1848	
110V AC	2.2 kW	4 kW	25 A	9 A		CJX2i-09110	
	3 kW	5.5 kW	25 A	12 A		CJX2i-12110	
	4 kW	7.5 kW	32 A	18 A		CJX2i-18110	
220 V AC	2.2 kW	4 kW	25 A	9 A		CJX2i-09220	
	3 kW	5.5 kW	25 A	12 A		CJX2i-12220	
	4 kW	7.5 kW	32 A	18 A		CJX2i-18220	
380 V AC	2.2 kW	4 kW	25 A	9 A	CJX2i-09220		
	3 kW	5.5 kW	25 A	12 A	CJX2i-12220		
	4 kW	7.5 kW	32 A	18 A	CJX2i-18220		

Contactur (Leshues) nga 11-18.5KW me bobina 24-48-110-220-380V AC Permasat TH(L) 97mm/ GJ (W) 56.5mm/L(H) 83mm

Bobina	Kapaciteti i fuqisë për AC-3		Ngarkesa		Kontakti ndihmës	Kodi	Çmimi
	220-230V	380-440V	AC-1	AC-3			
24 V AC	5.5 kW	11 kW	40 A	25 A	1 NO + 1NC	CJX2i-2524	
	7.5 kW	15 kW	50 A	32 A		CJX2i-3224	
	11 kW	18.5 kW	50 A	38 A		CJX2i-3824	
48 V AC	5.5 kW	11 kW	40 A	25 A		CJX2i-2548	
	7.5 kW	15 kW	50 A	32 A		CJX2i-3248	
	11 kW	18.5 kW	50 A	38 A		CJX2i-3848	
110V AC	5.5 kW	11 kW	40 A	25 A		CJX2i-25110	
	7.5 kW	15 kW	50 A	32 A		CJX2i-32110	
	11 kW	18.5 kW	50 A	38 A		CJX2i-38110	
220 V AC	5.5 kW	11 kW	40 A	25 A		CJX2i-25220	
	7.5 kW	15 kW	50 A	32 A		CJX2i-32220	
	11 kW	18.5 kW	50 A	38 A		CJX2i-38220	
380 V AC	5.5 kW	11 kW	40 A	25 A	CJX2i-25220		
	7.5 kW	15 kW	50 A	32 A	CJX2i-32220		
	11 kW	18.5 kW	50 A	38 A	CJX2i-38220		

Kontaktor nga 18.5-30KW me bobina 24-48-110-220-380V AC Permasat TH(L) 117mm/ GJ (W) 74.5mm/L(H) 127.5mm

Bobina	Kapaciteti i fuqisë për AC-3		Ngarkesa		Kontakti ndihmës	Kodi	Çmimi
	220-230V	380-440V	AC-1	AC-3			
24 V AC	11 kW	18.5 kW	60 A	40 A	1 NO + 1NC	CJX2i-4024	
	15 kW	22 kW	80 A	50 A		CJX2i-5024	
	18.5 kW	30 kW	80 A	65 A		CJX2i-6524	
48 V AC	11 kW	18.5 kW	60 A	40 A		CJX2i-4048	
	15 kW	22 kW	80 A	50 A		CJX2i-5048	
	18.5 kW	30 kW	80 A	65 A		CJX2i-6548	
110V AC	11 kW	18.5 kW	60 A	40 A		CJX2i-40110	
	15 kW	22 kW	80 A	50 A		CJX2i-50110	
	18.5 kW	30 kW	80 A	65 A		CJX2i-65110	
220 V AC	11 kW	18.5 kW	60 A	40 A		CJX2i-40220	
	15 kW	22 kW	80 A	50 A		CJX2i-50220	
	18.5 kW	30 kW	80 A	65 A		CJX2i-65220	
380 V AC	11 kW	18.5 kW	60 A	40 A	CJX2i-40220		
	15 kW	22 kW	80 A	50 A	CJX2i-50220		
	18.5 kW	30 kW	80 A	65 A	CJX2i-65220		

Kontaktor nga 37-45KW me bobina 24-48-110-220-380V AC Permasat TH(L) 125.5mm/ GJ(W) 85.5mm /L(H) 127.5mm

Bobina	Kapaciteti AC-3		Ngarkesa		Kontakti ndihmës	Kodi	Çmimi
	220-230V	380-440V	AC-1	AC-3			
24 V AC	22 kW	37 kW	125 A	80 A	1 NO + 1 NC	CJX2i-8024	
	25 kW	45 kW	125 A	95 A		CJX2i-9524	
48 V AC	22 kW	37 kW	125 A	80 A		CJX2i-8048	
	25 kW	45 kW	125 A	95 A		CJX2i-9548	
110V AC	22 kW	37 kW	125 A	80 A		CJX2i-80110	
	25 kW	45 kW	125 A	95 A		CJX2i-95110	
220 V AC	22 kW	37 kW	125 A	80 A		CJX2i-80220	
	25 kW	45 kW	125 A	95 A		CJX2i-95220	
380 V AC	22 kW	37 kW	125 A	80 A		CJX2i-80220	
	25 kW	45 kW	125 A	95 A		CJX2i-95220	



Rele Termike per leshuesh 4-18.5KW

Ngarkesa	Kontaktori	Klasi	Frekuenca	Kodi	Çmimi
1.6 - 2.5 A	CJX2i09-38	10 A	50-60Hz	JR28S-2507	
2.5 - 4 A				JR28S-2508	
4 - 6 A				JR28S-2510	
7 - 10 A				JR28S-2514	
9 - 13 A				JR28S-2516	
12 - 18 A				JR28S-2521	
17 - 25A				JR28S-2522	
23 - 32 A				JR28S-2532	



Rele Termike per leshuesh 18.5-30KW

Ngarkesa	Kontaktori	Klasi	Frekuenca	Kodi	Çmimi
23 - 32 A	CJX2i40-65		50-60Hz	JR28S-3632	
28 - 36 A				JR28S-3636	



Rele Termike per leshuesh 18.5-45KW

Ngarkesa	Kontaktori	Klasi	Frekuenca	Kodi	Çmimi
37 - 50 A	CJXi80-95		50-60Hz	JR28S-9350	
48 - 65 A				JR28S-9365	

Mini Leshues 2.2-5.5 KW

Bobina	Kapaciteti i fuqisë për AC-3		Ngarkesa		Kontakti ndihmës	Kodi	Çmimi
	220-230V	380-440V	AC-1	AC-3			
24 V AC	1.5 kW	2.2 kW		6 A	1NO	CJX2K-06B7	
	2.2 kW	4 kW	20 A	9 A		CJX2K-09B7	
	3 kW	5.5 kW	20 A	12 A		CJX2K-12B7	
220 V AC	1.5 kW	2.2 kW		6 A		CJX2K-06M7	
	2.2 kW	4 kW	20 A	9 A		CJX2K-09M7	
	3 kW	5.5 kW	20 A	12 A		CJX2K-12M7	

Rele Termike per mini leshuesh 2.2-5.5KW

Ngarkesa	Kontaktori	Klasi	Frekuenca	Kodi	Çmimi
1.6 - 2.5 A	CJX2K06-12		50-60Hz	JR28K-1102	
2.5 - 4 A				JR28K-1104	
4 - 6 A				JR28K-1106	
5.5 - 8 A				JR28K-1108	
7 - 10A				JR28K-1110	
9 - 13 A				JR28K-1113	



Kontakte ndihmese per lëshues CJX1



Lloji	Koha	Kodi	Çmimi
Kontakti Anësor	1 NO + 1 NC	F4-DN11	
	2 NO	F4-DN20	
	2 NC	F4-DN02	
	2 NO + 2NC	F4-DN22	
	4 NO	F4-DN40	
	1 NO- 3NC	F4-DN13	
	4NC	F4-DN04	

Rele kohe per lëshues

Lloji	Koha	Kontakti	Kodi	Çmimi
Kontakti Ndezës	0.1 - 3 sek		LA2-DT0	
	0.1 - 30 sek		LA2-DT2	
	10 - 180 sek	1 NO + 1 NC	LA2-DT4	
Kontakti Fikës	0.1 - 3 sek	1 NO + 1 NC	LA2-DR0	
	0.1 - 30 sek		LA2-DR2	
	10 - 280 sek		LA2-DR4	

Bobinë per lëshues nga 4KW-45KW me tension 24-48-110-220-380V AC

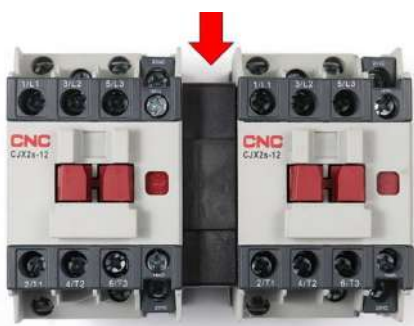
Tensioni i qarkut	Kontaktori	Rezistenca	Frekuenca	Kodi	Çmimi	
24 V	9A - 38A	5.37 Ω	50/60 Hz	LX1-D2E7		
48 V		21.7 Ω				
110V		124.1 Ω				
220V		515.4 Ω				
380V		1551 Ω				
24 V	40A - 65A	1.98 Ω		LX1-D4B7		LX1-D4F7
48 V		7.97 Ω				
110V		42.28 Ω				
220V		182 Ω				
380V		512 Ω				
24 V	80A - 95A	1.4 Ω	LX1-D6B7	LX1-D6F7		
48 V		5.5 Ω				
110V		31 Ω				
220V		127 Ω				
380 V		381 Ω				

Bllokues mekanik per lëshues

Per Leshues	Kodi	Çmimi
4-7.5 KW	CJXi2-18N	
11-18.5 KW	CJXi2-38N	
18.5-30 KW	CJXi2-65N	
37-45 KW	CJXi2-95N	

Kuti per lëshues plus rele termike

Kontakti	Izolimi	Lëshues+Rele	Kodi	Çmimi
1NO-1NC	IP55	4-7.5KW	LE1-18A	
		11-18.5 KW	LE1-38A	
		18.5-30 KW	LE1-65A	



Kuti per lëshues plus rele termike

Intervali i rrymës	Kapaciteti i fuqisë për AC-3			Kodi	Çmimi
	220V	380V	500V		
0.63-1.00 A	-	-	0.37KW		
1.00-1.60 A	-	0.37KW	0.75 KW	YCP5-25ME06	
1.60-2.50 A	0.37KW	0.75 KW	1.1 kW	YCP5-25ME07	
2.50-4.00 A	0.75 KW	1.5 kW	2.2 kW	YCP5-25ME08	
4.00-6.30 A	1.1 kW	2.2 kW	3.7 kW	YCP5-25ME10	
6.00-10.0 A	2.2 kW	4 kW	5.5 kW	YCP5-25ME14	
9.0-14.0 A	3 kW	5.5 kW	7.5 kW	YCP5-25ME16	
13.0-18.0	4 kW	7.5 kW	9 kW	YCP5-25ME20	
17.0-23.0A	5.5 kW	11 kW	11 kW	YCP5-25ME21	
24.0-32.0 A	7.5 kW	15 kW	18.5 kW	YCP5-25ME32	



Rele nen-mbitension			Kontakte per salvamotor			Shunt rele per salvamotor		
Kodi	Voltazhi	Çmimi	Kodi	Kontakti	Çmimi	Kodi	Voltazhi	Çmimi
YCP5-25AU115	110V 50Hz		YCP5-25AE11	1 NO + 1 NC		YCP5-25AS115	24V 50Hz	
YCP5-25AU225	220V 50Hz		YCP5-25AE20	2 NO		YCP5-25AS225	220V 50Hz	
YCP5-25AU385	400V 50Hz		YCP5-25AN11	1 NO + 1 NC		YCP5-25AS385	400V 50Hz	
			YCP5-25AN20	2 NO				



YCP5-25AE11



YCP5-25AN11



Kuti per lëshues plus rele termike



ME25MC01

Kodi	IZOLIMI	Çmimi
ME25MC01	IP55	
ME25MC02	IP55	



ME25MC02

CNC

Automat Modular - Rated breaking capacity 6000 (RCCB) Tipi AC

Automat YCB9-80M 1-Polar 6-80A 50/60hz



Ngarkesa	Kodi	Çmimi
6A	YCB9-80M1P06	
10A	YCB9-80M1P10	
16A	YCB9-80M1P16	
20A	YCB9-80M1P20	
25A	YCB9-80M1P25	
32A	YCB9-80M1P32	
40A	YCB9-80M1P40	
50A	YCB9-80M1P50	
63A	YCB9-80M1P63	
80A	YCB9-80M1P80	

Automat YCB9-80M 4-Polar 6-80A 50/60hz



Ngarkesa	Kodi	Çmimi
6A	YCB9-80M4P06	
10A	YCB9-80M4P10	
16A	YCB9-80M4P16	
20A	YCB9-80M4P20	
25A	YCB9-80M4P25	
32A	YCB9-80M4P32	
40A	YCB9-80M4P40	
50A	YCB9-80M4P50	
63A	YCB9-80M4P63	
80A	YCB9-80M4P80	

Automat YCB9-80M 2-Polar 6-80A 50/60hz



Ngarkesa	Kodi	Çmimi
6A	YCB9-80M2P06	
10A	YCB9-80M2P10	
16A	YCB9-80M2P16	
20A	YCB9-80M2P20	
25A	YCB9-80M2P25	
32A	YCB9-80M2P32	
40A	YCB9-80M2P40	
50A	YCB9-80M2P50	
63A	YCB9-80M2P63	
80A	YCB9-80M2P80	

Automat YCB9-80M 3-Polar 6-80A 50/60hz



Ngarkesa	Kodi	Çmimi
6A	YCB9-80M3P06	
10A	YCB9-80M3P10	
16A	YCB9-80M3P16	
20A	YCB9-80M3P20	
25A	YCB9-80M3P25	
32A	YCB9-80M3P32	
40A	YCB9-80M3P40	
50A	YCB9-80M3P50	
63A	YCB9-80M3P63	
80A	YCB9-80M3P80	

Automat YCB9NL-40 1P+N 6-40A 50/60hz



Ngarkesa	Kodi	Çmimi
6A	YCB9N40-1PN06	
10A	YCB9N40-1PN10	
16A	YCB9N40-1PN16	
20A	YCB9N40-1PN20	
25A	YCB9N40-1PN25	
32A	YCB9N40-1PN32	
40A	YCB9N40-1PN40	

Salvavit Tipi AC YCB9RL-100 1P+N,3P+N 16-63A 50/60hz



Ngarkesa	Pole	Kodi	Çmimi
25A	1P+N	YCB9RL100-1P25C	
32A	1P+N	YCB9RL100-1P32C	
40A	1P+N	YCB9RL100-1P40C	
25A	3P+N	YCB9RL100-3P25C	
32A	3P+N	YCB9RL100-3P32C	
40A	3P+N	YCB9RL100-3P40C	
50A	3P+N	YCB9RL100-3P50C	
63A	3P+N	YCB9RL100-3P63C	

CNC

Salvavita Modular - Capaciteti 6000A (RCCB-RCBO) Tipi A-AC

Salvavit 1P+N YCB9L-40 RCBO Tipi A



Ngarkesa	Pole	Kodi	Çmimi
10A	1P+N	YCB9L40-2P10	
16A	1P+N	YCB9L40-2P16	
20A	1P+N	YCB9L40-2P20	
25A	1P+N	YCB9L40-2P25	
32A	1P+N	YCB9L40-2P32	
40A	1P+N	YCB9L40-2P40	

Salvavit Tipi A YCB9RL-100 1P+N,3P+N 25-63A 50/60hz



Ngarkesa	Pole	Kodi	Çmimi
25A	1P+N	YCB9RL100-1P25A	
32A	1P+N	YCB9RL100-1P32A	
40A	1P+N	YCB9RL100-1P40A	
25A	3P+N	YCB9RL100-3P25A	
32A	3P+N	YCB9RL100-3P32A	
40A	3P+N	YCB9RL100-3P40A	
50A	3P+N	YCB9RL100-3P50A	
63A	3P+N	YCB9RL100-3P63A	

Salvavit 1P+N YCB9LE-80M 16-80A 50/60hz



Ngarkesa	Pole	Kodi	Çmimi
16A	1P+N	YCB9LE-80M2P16	
20A	1P+N	YCB9LE-80M2P20	
25A	1P+N	YCB9LE-80M2P25	
32A	1P+N	YCB9LE-80M2P32	
40A	1P+N	YCB9LE-80M2P40	
63A	1P+N	YCB9LE-80M2P63	
80A	1P+N	YCB9LE-80M2P80	

Salvavit 3P+N YCB9LE-80M 16-80A 50/60hz



Ngarkesa	Pole	Kodi	Çmimi
16A	3P+N	YCB9LE-80M4P16	
20A	3P+N	YCB9LE-80M4P20	
25A	3P+N	YCB9LE-80M4P25	
32A	3P+N	YCB9LE-80M4P32	
40A	3P+N	YCB9LE-80M4P40	
63A	3P+N	YCB9LE-80M4P63	
80A	3P+N	YCB9LE-80M4P80	

Automat YCB9ZF-100W 1-Polar 16-100A 50/60hz

Ngarkesa	Kodi	Çmimi
16A	YCB9ZF-100W1P16	
20A	YCB9ZF-100W1P20	
25A	YCB9ZF-100W1P25	
32A	YCB9ZF-100W1P32	
40A	YCB9ZF-100W1P40	
50A	YCB9ZF-100W1P50	
63A	YCB9ZF-100W1P63	
80A	YCB9ZF-100W1P80	
100A	YCB9ZF-100W1P100	



Automat YCB9ZF-100W 4-Polar 16-100A 50/60hz

Ngarkesa	Kodi	Çmimi
16A	YCB9ZF-100W4P16	
20A	YCB9ZF-100W4P20	
25A	YCB9ZF-100W4P25	
32A	YCB9ZF-100W4P32	
40A	YCB9ZF-100W4P40	
50A	YCB9ZF-100W4P50	
63A	YCB9ZF-100W4P63	
80A	YCB9ZF-100W4P80	
100A	YCB9ZF-100W4P100	



Automat YCB9ZF-100W 2-Polar 16-100A 50/60hz

Ngarkesa	Kodi	Çmimi
16A	YCB9ZF-100W2P16	
20A	YCB9ZF-100W2P20	
25A	YCB9ZF-100W2P25	
32A	YCB9ZF-100W2P32	
40A	YCB9ZF-100W2P40	
50A	YCB9ZF-100W2P50	
63A	YCB9ZF-100W2P63	
80A	YCB9ZF-100W2P80	
100A	YCB9ZF-100W2P100	



Automat YCB9ZF-100W 3-Polar 16-100A 50/60hz

Ngarkesa	Kodi	Çmimi
16A	YCB9ZF-100W3P16	
20A	YCB9ZF-100W3P20	
25A	YCB9ZF-100W3P25	
32A	YCB9ZF-100W3P32	
40A	YCB9ZF-100W3P40	
50A	YCB9ZF-100W3P50	
63A	YCB9ZF-100W3P63	
80A	YCB9ZF-100W3P80	
100A	YCB9ZF-100W3P100	



Automat YCB9ZF-100AP 2-Polar 16-100A 50/60hz

Ngarkesa	Kodi	Çmimi
16A	YCB9ZF-100AP2P16	
20A	YCB9ZF-100AP2P20	
25A	YCB9ZF-100AP2P25	
32A	YCB9ZF-100AP2P32	
40A	YCB9ZF-100AP2P40	
50A	YCB9ZF-100AP2P50	
63A	YCB9ZF-100AP2P63	
80A	YCB9ZF-100AP2P80	
100A	YCB9ZF-100AP2P100	



Automat YCB9ZF-100AP 3-Polar 16-100A 50/60hz

Ngarkesa	Kodi	Çmimi
16A	YCB9ZF-100AP3P16	
20A	YCB9ZF-100AP3P20	
25A	YCB9ZF-100AP3P25	
32A	YCB9ZF-100AP3P32	
40A	YCB9ZF-100AP3P40	
50A	YCB9ZF-100AP3P50	
63A	YCB9ZF-100AP3P63	
80A	YCB9ZF-100AP3P80	
100A	YCB9ZF-100AP3P100	



YCWF-Y02

Leshues (contactor) Modular YCCH6

Ngarkesa	Module	Pole	Kodi	Çmimi
16A	1	2	YCCH6-181620	
20A	1	2	YCCH6-182020	
25A	1	2	YCCH6-182520	
32A	1	2	YCCH6-363220	
32A	2	2	YCCH6-363240	
40A	2	2	YCCH6-364040	
63A	2	2	YCCH6-366340	
40A	4	4	YCCH6-5404040	
63A	4	4	YCCH6-5406340	
100A	4	4	YCCH6-5410040	

Leshues (contactor) Modular YCCH7

Ngarkesa	Module	Pole	Kodi	Çmimi
32A	2	2	YCCH7-363240	
40A	2	2	YCCH7-364040	
63A	2	2	YCCH7-366340	
40A	4	4	YCCH7-5404040	
63A	4	4	YCCH7-5406340	
100A	4	4	YCCH7-5410040	

Kontakti	Kodi	Çmimi
2NO	YCCH6-2NO	
1NO+1NC	YCCH6-1NO1NC	
Bllokues	YCCH6	

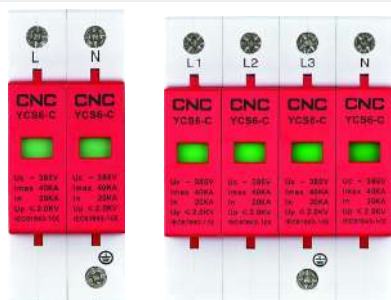
Mbrojtëse mbitensioni dhe rufeje YCS6-C 25-32 Amper

Ngarkesa	I _{max} (8/20μs)kA	I _n (8/20μs) kA	Pole	Kodi	Çmimi
32A			1	YCS6-C1	
40A	5/10	10/20	2	YCS6-C2	
63A			3	YCS6-C3	
40A			4	YCS6-C4	

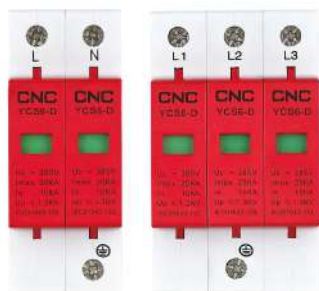
Mbrojtëse mbitensioni dhe rufeje YCS6-D 10-25 Amper

Ngarkesa	I _{max} - (8/20μs)kA	I _n (8/20μs) kA	Pole	Kodi	Çmimi
32A			1	YCS6-D1	
40A	5/10	10/20	2	YCS6-D2	
63A			3	YCS6-D3	
40A			4	YCS6-D4	

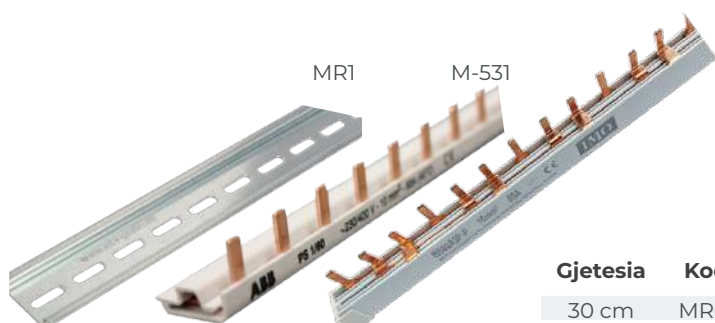
Shina dhe bashkues automatesh

Gjatesia	Fuqia	Kodi	Çmimi
53 cm	80A	M-531	
106 cm	80A	M-1061	
53 cm	100A	M-5315	
106 cm	100A	M-10615	

Gjatesia	Kodi	Çmimi	Gjatesia	Fuqia	Kodi	Çmimi
30 cm	MR03		53 cm	80A	T-531	
100 cm	MR1		106 cm	80A	T-1061	
			53 cm	100A	T-5315	
			106 cm	100A	T-10615	

Llamba sinjali 1/2 dhe 1 Module

Module	Pole/faze	Kodi	Çmimi
½ Modul	1 Polare e kuqe	YCD9-1R	
	1 Polare jeshile	YCD9-1G	
	2 Polare	YCD9-2RG	
1 Modul	3 Polare	YCD9-3RGY	
	1 Polare e kuqe	ADM-1R	
	1 Polare jeshile	ADM-1G	
	2 Polare	ADM-2RG	
	3 Polare	ADM-3RGY	

Rele nen dhe mbitensioni 2P 40A

Mbrojtësi i mbitensionit dhe nëntensionit vetë-rikuperues është një mbrojtës inteligjent. Në rast të mbitensionit ose nëntension të linjës, mbrojtësi hap qarkun dhe ben të mundur heqjen e energjis për të mbrojtur pasisjet. Kur voltazhi rifillon vlerën normale, mbrojtësi do të mbyllë automatikisht qarkun brenda kohës së caktuar për të kthyer funksionimin normal të energjis. Mbrojtësi i mbitensionit dhe nëntensionit vetë-rikuperues aplikohet për përdoruesit ose ngarkesat e AC 230V, 50Hz. Përdoret kryesisht në kutinë e shpërndarjes shtëpiake ose në linjën tjetër të shpërndarjes që kërkon mbrojtje.

Fuqia	Tensioni Minimal	Tensioni Maksimal	Koha e fiksjes	Kodi	Çmimi
40A	165V AC	275V AC	20-60S	YCZF6	
40A	140V AC	300V AC	1-30S	YC6VA	

YCZF6

YC6VA

Rele Shkalle 16A

Releja e kohës ben të mundur ndezjen ose fiksjen e drites pasi përdoruesi ka bërë njerin nga veprimet. Shembull: Banori i pallatit ndez dritën në katin e parë dhe i duhen 3 minuta për tu ngjitur në katin pestë që në të kursejme energji atehere e regjistrojme që për 5 minuta pas ndezjes dritat e pallatit të fikën.

Fuqia	Voltazhi	Koha e fiksjes	Kodi	Çmimi
16A	230V AC	0.5-20 MIN	YCT8-LS	

Voltmeter Modulare Digjital 1 Faze dhe 3 Fazor

Voltazhi	Faze	Kodi	Çmimi
80-500V AC	1 Faze	YCMV-1G	
80-500V AC	3 Faze	YCMV-3G	

Voltmeter Modulare Digjital 1 Faze dhe 3 Fazor

Fuqia	Voltazhi	Pole	Frekuenca	Kodi	Çmimi
16A	220V AC	2P+PE	40-60 Hz	TMS-5	



CNC

Çelës (Gjenerator) automatik per nderrim linje YCQ1B, YCQ6B ,YCQ9Ms

Celes Automatik per ndyshim linje seria YCQ1B 2-Polar nga 10A-63A



Ngarkesa	Pole	Kodi	Çmimi
40A	2P+2P	YCQ1B-2P40A	
63A	2P+2P	YCQ1B-2P63A	

Celes Automatik per ndyshim linje seria YCQ1B 4-Polar nga 10A-63A



Ngarkesa	Pole	Kodi	Çmimi
40A	4P+4P	YCQ1B-4P40A	
63A	4P+4P	YCQ1B-4P63A	

Celes Automatik per ndyshim linje seria YCQ9Ms 4-Polar nga 10A-800A



Ngarkesa	Pole	Kodi	Çmimi
80A	4P+4P	YCQ9Ms-4P80A	
100A	4P+4P	YCQ9Ms-4P100A	
120A	4P+4P	YCQ9Ms-4P125A	

15

INVERTER





ÇFARË JANË INVERTERËT DRIVER DHE CILI ËSHTË FUNKSIONI I TYRE?

Inverter driver-at, ose inverterët, janë pajisje elektronike që përdoren për të kontrolluar shpejtësinë dhe drejtimin e një motori elektrik. Këto pajisje janë pjesë e sistemeve të drejtimit të motorëve elektrikë dhe janë shumë të rëndësishme për funksionimin e tyre efikas dhe të sigurt.

Për të kuptuar rolin e tyre, është e rëndësishme të kuptohet se si funksionojnë motorët elektrikë. Motorët elektrikë punojnë duke konvertuar energjinë elektrike në energji mekanike për të kryer punën e tyre. Ata kanë nevojë për një burim tensioni të vazhdueshëm, i cili ndryshon shpejtësinë dhe drejtimin e tyre.

Inverter driver-at ndihmojnë në këtë proces duke kontrolluar tensionin dhe frekuencën e tensionit elektrik të dërguar në motor. Ata përdorin teknologji të ndryshme për të shndërruar tensionin e furnizuar nga burimi i tensionit të vazhdueshëm (AC) në një formë që motori mund të përdoret për të funksionuar në shpejtësi dhe drejtimin e dëshiruar.

PËR ÇFARË PËRDOREN?

Kontrolli i shpejtësisë dhe drejtimi: Inverterët ofrojnë një mënyrë të kontrolluar dhe të precizuar për të ndryshuar shpejtësinë dhe drejtimin e motorit, duke bërë ato të përshtatshme për një gamë të gjerë aplikacionesh.

Efikasitet: Duke kontrolluar shpejtësinë e motorit, inverterët mund të përmirësojnë efikasitetin e përgjithshëm të sistemit, duke konsumuar më pak energji dhe duke zvogëluar shpenzimet operative.

Fleksibilitet: Inverterët ofrojnë një gamë të gjerë të funksioneve dhe mundësive të programueshme, duke lejuar përshtatjen e tyre për nevojat specifike të aplikacioneve të ndryshme.

CILA ËSHTË SERIA MË E MIRË E INVERTERAVE?

Seria GD20-EU është produkti më i shitur markes INVT. Gama deri në 110 KW, prania e filtrit të integruar EMC me fuqi 4 KW (opsioni në prizë për madhësi deri në 2.2 KW), shperndares (CHOPER) standard i frenimit, deri në 37 KW fuqi, e bëjnë GD20-EU një nga inverterët më të plotë globalisht. Kontrolli vektorial pa sensor me funksionin e akordimit statik ose dinamik i lejon GD20-EU të menaxhojë më mirë aplikimet në makinat dhe sistemet e përkthimit dhe ngritjes.

Një rezistencë standarde frenimi është një komponent i gjetur zakonisht në sistemet e drejtimit të motorit, veçanërisht në shkathtësitë e frekuencës së ndryshueshme (VFDs) ose inverterët. Qëllimi i tij është të shpërndajë energjinë e tepërt kinetike të prodhuar nga motori gjatë ngadalësimit ose frenimit. Kur një motor është duke ngadalësuar ose frenuar, ai vepron si një gjenetator, duke prodhuar energji që duhet të shpërndahet në ndonjë mënyrë për të parandaluar dëmtimin e motorit ose sistemit të drejtimit. Pa një rezistencë frenimi, kjo energji e tepërt mund të shkaktojë kushte teje të larta të voltazhit brenda drejtimit, duke dëmtuar potencialisht komponentët e saj.

Kodi	Fuqia e motorit	Tensioni	W (mm) Gjerësia	H (mm) Lartësia	D (mm) 140.5mm	Çmimi
GD20-0R7G-4	0.75 kW	400V	80mm	185mm	140.5mm	
GD20-1R5G-4	1.50 kW					
GD20-2R2G-4	2.20 kW					



Kodi	Fuqia e motorit	Tensioni	W (mm) Gjerësia	H (mm) Lartësia	D (mm) 140.5mm	Çmimi
GD20-004G-4	4.0 kW	400V	146mm	256mm	167mm	
GD20-5R5G-4	5.5 kW					



KU APLIKOHEN?

Produktet e platformës së kontrollit të vektorit, performanca e fuqishm dhe e shkëlqyer, mund të përdoren gjerësisht në aplikime me fuqi të vogël dhe të mesme të tilla si pajisje transporti si Vinça, makineri ushqimore, makineri plastike, pajisje qeramike, makineri naftë, makineri kabllorë, kompresorë ajri, vegla makinerie, makineri për përpunimin e drurit, makineri tekstile, pajisje printimi dhe paketimi, pajisje kimike, pajisje për mbrojtjen e mjedisit, etj.

Kodi	Fuqia e motorit	Tensioni	W (mm) Gjerësia	H (mm) Lartësia	D (mm) 140.5mm	Çmimi
GD20-7R5G-4	7.5 kW	400V	170mm	320mm	196.3mm	
GD20-011G-4	11 kW					
GD20-015G-4	15 kW					



Kodi	Fuqia e motorit	Tensioni	W (mm) Gjerësia	H (mm) Lartësia	D (mm) 140.5mm	Çmimi
GD20-018G-4	18.5 kW	400V	200mm	340.6mm	184.3mm	
GD20-022G-4	22 kW					

Kodi	Fuqia e motorit	Tensioni	W (mm) Gjerësia	H (mm) Lartësia	D (mm) 140.5mm	Çmimi
GD20-030G-4	30 kW	400V	250mm	400mm	202mm	
GD20-037G-4	37 kW					





KU APLIKOHET SERIA GD-10?

Paketim, ushqim, tekstile, makineri centrifugale, makineri gdhendje dhe prerje teli.

Kodi	Fuqia e motorit	Tensioni	W (mm) Gjerësia	H (mm) Lartësia	D (mm) Thellessia	Çmimi
GD10-0R7G-S-B	0.75 kW	220V	85mm	140mm	153.2mm	
GD10-1R5G-S-B	1.50 kW		100mm	165mm	153.2mm	
GD10-2R2G-S-B	2.20 kW					



KU APLIKOHET SERIA GD-200A?

Kompresor Ajri, Vaj, Ngrohje dhe Furnizimi me Ujë, Makinë Plastike, Miniera, Ventilatorë dhe Pompa Uji.

Kodi	Fuqia e motorit	Tensioni	W (mm) Gjerësia	H (mm) Lartësia	D (mm) 140.5mm	Çmimi
GD200A-2R2G-4	2.2 kW	380V	275mm	205mm	235mm	
GD200A-004G-4	4-5.5 kW		360mm	250mm	265mm	
GD200A-5R5G-4	5.5-7.5 kW		445mm	295mm	320mm	
GD200A-7R5G-4	7.5-11 kW					
GD200A-011G-4	11-15 kW					
GD200A-015G-4	15-18.5 kW	380V	460mm	340mm	330mm	
GD200A-018G-4	18.5-22 kW		540mm	375mm	375mm	
GD200A-022G-4	22-30 kW					



KU APLIKOHET SERIA GD-350?

Industrinë e ndërtimit si në vinça, industrinë e metaleve si tornot, industrinë e printimit dhe paketimit dhe në industrinë tekstile.

Kodi	Fuqia e motorit	Tensioni	W (mm) Gjerësia	H (mm) Lartësia	D (mm) 140.5mm	Çmimi
GD350-7R5G-4	7.5	380V	146 mm	256 mm	192 mm	
GD350-011G-4	11 kW		170 mm	320 mm	220 mm	
GD350-015G-4	15 kW		200 mm	241 mm	208 mm	
GD350-018G-4	18.5 kW		200 mm	241 mm	208 mm	
GD350-022G-4	22 kW		250 mm	400 mm	223 mm	
GD350-030G-4	30 kW		250 mm	400 mm	223 mm	
GD350-037G-4	37 kW					



REZISTENCA FRENIMI

Kodi	Ohm	Wat	Per inverter me fuqi	Çmimi
ROF20/250	250-Ohm	150W	0.75-1.5 kW	
ROF35/150	150-Ohm	350W	2.2-4 kW	
ROF50/35	35-Ohm	500W	4-5.5 kW	
ROF80R/60	60-Ohm	800W	7.5-11 kW	
ROF80R/30	30-Ohm	800W	15-18.5 kW	

16

KONDENSATORË



Kondensatorë pune 400-475 V ,të serisë 416.10

Të dhenat teknike
 400 V ~ 10000 h cl. B 25/85/21
 425 V ~ 10000 h cl. B 25/85/21
 450 V ~ 3000 h Ocl. C 25/85/21
 475 V ~ 3000 h Ocl. C 25/85/21

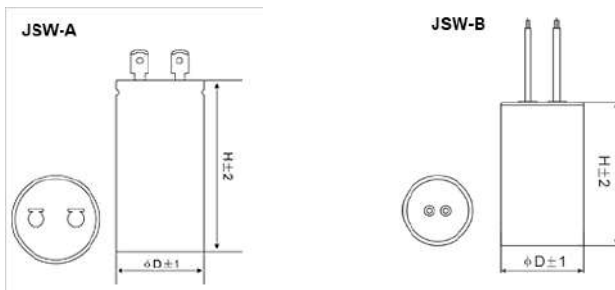

416.10	Tensioni/Voltazhi		400 V ~ 10000 h cl. B 25/85/21 425 V ~ 10000 h cl. B 25/85/21 450 V ~ 3000 h Ocl. C 25/85/21 475 V ~ 3000 h Ocl. C 25/85/21			
C(µF)	DxH (mm)	Kodi	Çmimi	DxH (mm)	Kodi	Çmimi
2	25x49	DC02		28x55	Ska	
2,5	25x49	DC02.5		28x55	Ska	
3	25x49	DC03		28x55	Ska	
3,15	25x49	DC03.15		28x55	Ska	
3,5	25x55	DC03.5		28x55	Ska	
4	25x55	DC04		28x55	Ska	
4,5	28x55	DC4.5		28x55	Ska	
5	28x55	DC05		28x55	Ska	
5,5	30x56	DC05.5		32x55	Ska	
6	30x56	DC06		32x55	Ska	
6,3	30x56	DC06.3		32x55	Ska	
8	36x58	DC08		32x55	KB08	
10	36x58	DC10		30x70	KB10	
12	36x70	DC12			KB12	
12,5	36x70	DC12.5		36x58	KB12.5	
14	36x70	DC14		40x70	KB14	
16	36x70	DC16		40x70	KB16	
18	40x70	DC18		45x70	KB18	
20	40x70	DC20		45x92	KB20	
25	40x70	DC25		45x70	KB25	
25/1	40x92	DC25/1			KB25/1	
30	40x92	DC30		45x70	KB30	
31,5	45x92	DC31.5		40x92	KB31.5	
35	45x92	DC35			KB35	
40	45x92	DC40		50x92	KB40	
45	45x117	DC45		50x92	KB45	
50	45x117	DC50		50x92	KB50	
55	45x117	DC55		50x92	KB55	
60	50x117	DC60		55x92	KB60	
70	50x117	DC70			KB70	
80	55x120	DC80			KB80	
100	-	DC100			KB100	

Kondensatorë starti 220-250-330 V

Dimensionet:
 A = 36,5 x 68,5
 B = 45,5 x 84
 C = 52 x 105
 D = 65 x 111



Kapacitor (µF)	220 V		250 V		330V	
	C min C max Cn. (Toll.)	Dim Kodi DC22	Dim Kodi DC25	CMIMI	Dim Kodi DC33	
36÷43	A	DC22036043	A	DC25036043	A	DC33036043
43÷52	A	DC22043052	A	DC25043052	A	DC33043052
53÷64	A	DC22053064	A	DC25053064	B	DC33053064
64÷77	A	DC22064077	A	DC25064077	B	DC33064077
72÷86	A	DC22072086	B	DC25072086	B	DC33072086
88÷106	B	DC22088106	B	DC25088106	B	DC33088106
108÷130	B	DC22108130	B	DC25108130	C	DC33108130
130÷156	B	DC22130156	B	DC25130156	C	DC33130156
145÷174	B	DC22145174	B	DC25145174	C	DC33145174
161÷193	B	DC22161193	B	DC25161193	C	DC33161193
189÷227	B	DC22189227	B	DC25189227	C	DC33189227
216÷260	B	DC22216260	C	DC25216260	D	DC33216260
243÷292	C	DC22243292	C	DC25243292	D	DC33243292
270÷324	C	DC22270324	C	DC25270324	D	DC33270324
324÷389	C	DC22324389	C	DC25324389	D	DC33324389

Trasformatorë voltazhi input 220-380 V/AC, output 12-24-36-48-110 V/AC

CNC

Trasformator Voltazhi Input 220-380V AC Output 12-24V AC

Kapaciteti VA	Primari Inputi	Secondari	Kodi	Çmimi
60	220-380V AC +-5%	12-24V	JBK5-601224	
100			JBK5-1001224	
160			JBK5-1601224	
250			JBK5-2501224	
400			JBK5-4001224	
630			JBK5-6301224	
800			JBK5-8001224	



Trasformator Voltazhi Input 220-380V AC Output 24-36-48V AC

Kapaciteti VA	Primari Inputi	Secondari	Kodi	Çmimi
60	220-380V AC +-5%	24-36-48V	JBK5-602448	
100			JBK5-1002448	
160			JBK5-1602448	
250			JBK5-2502448	
400			JBK5-4002448	
630			JBK5-6302448	
800			JBK5-8002448	



Trasformator Voltazhi Input 220-380V AC Output 24-110V AC

Kapaciteti VA	Primari Inputi	Secondari	Kodi	Çmimi
60	220-380V AC +-5%	24-110V	JBK5-6024110	
100			JBK5-10024110	
160			JBK5-16024110	
250			JBK5-25024110	
400			JBK5-40024110	
630			JBK5-63024110	
800			JBK5-80024110	



Trasformator Voltazhi Input 220-380V AC Output 24-110V AC

Kapaciteti VA	Primari Inputi	Secondari	Kodi	Çmimi
60	220-380V AC +-5%	24 V	JBK5-6024	
100			JBK5-10024	
160			JBK5-16024	
250			JBK5-25024	
400			JBK5-40024	
630			JBK5-63024	
800			JBK5-80024	



Kondesator trefazor

Tensioni Nominal (kV)	Kapaciteti Vlersimit (Kvar)	Kapaciteti Vlersimit (µF)	Vleresimi Rrymes (A)	H Lartësia (mm)	Terminali dalës	Çmimi
0.525	5	57.7	5.5	125	M6	
	10	115.5	11.0	180	M6	
	15	173.2	16.5	210	M6	
	18	207.9	19.8	210	M6	
	21	231.0	22.0	210	M6	
	25	288.9	27.5	210	M8	
	30	346.6	33.0	260	M8	
	40	462.2	44.0	330	M8	
	50	577.7	55.0	230	M10	
	60	693.3	66.0	230	M10	



Ushqyes me hyrje AC 180-264V dhe Dalje 12,24,36 dhe 48V DC

Output fuqia	Primari Inputi	Secondari	Kodi	Çmimi
12V 3A	85-264V AC	12V DC	MS-3512	
12V 5A			S-6012	
12V 10A			S-12012	
12V 20A			S-25012	
24V 1.5A		24V DC	MS-3524	
24V 2.5A			S-6024	
24V 5A			S-12024	
24V 10A			S-25024	

Ushqyes me hyrje AC 180-264V dhe Dalje 12,24,36 dhe 48V DC

Output fuqia	Primari Inputi	Secondari	Kodi	Çmimi
6.3 A	85-264V AC	12V DC	DR07512	
10 A			DR12012	
3.2 A		24V DC	DR07524	
5 A			DR12024	

Stabilizator voltazhi 95% efcience nga 500VA-10000VA

Fuqia	Primari Inputi	Output	Kodi	Çmimi
500VA	150-250V AC	220V AC +8%	AVR-500VA	
1000VA			AVR-1000VA	
1500VA			AVR-1500VA	
2000VA			AVR-2000VA	
3000VA			AVR-3000VA	
5000VA			AVR-5000VA	
8000VA			AVR-8000VA	
10000VA			AVR10KVA	

Rregullator voltazhi 0-250 V dhe 0-430V

Kapaciteti VA	Pri	Sec	Dalja Maksimale	Kodi	Çmimi
1	220V	0-250 V	4 A	TDGC2-1	
2			8 A	TDGC2-2	
3			12 A	TDGC2-3	
5			20 A	TDGC2-5	
10			40 A	TDGC2-10	
15			60 A	TDGC2-15	
20			80 A	TDGC2-20	

Kapaciteti VA	Pri	Sec	Dalja Maksimale	Kodi	Çmimi
3	380V	0-430 V	4 A	TSGC2-3	
6			8 A	TSGC2-6	
9			12 A	TSGC2-9	
15			20 A	TSGC2-15	
20			26.5 A	TSGC2-20	
30			40 A	TSGC2-30	

www.albbaker.com

17

PJESË MOTORIKE

Helika
Kushineta
Permistopa

Nachi-Fujikoshi është një korporatë japoneze e krijuar në vitin 1928 nga Kohki Imura. Aktiviteti i saj fillestar ishte i fokusuar në prodhimin e pajisjeve prerese, dhe në vitin 1939 filloi prodhimin e kushinetave. Nachi Group është i përbërë nga 53 kompani, nga të cilat 23 ndodhen brenda vendit ndërsa 30 të tjera jashtë tij, ku 4 në Amerikë, 2 Meksikë, Kanada, Gjermani, Britani, Singapor, Australi, Brazil, etj. Produktet kryesore: Kushinetat, Robotët, Sistemet robotike, Çelik special, Furrat industriale, Vegla prerese etj.



TRENDET E FUNDIT të makinerive industriale tregojnë një nevojë në rritje për kushineta të afta për të përballuar shpejtësi dhe temperatura të larta.

Nachi QUEST është markë që plotëson këto kërkesa të tregut në rritje, që ndryshojnë çdo ditë. **Kushinetat ZZE** me kapakun metalik kanë shpejtësi më të larta dhe përdoren për pajisje që punojnë në kushte normale. Kurse ato **2NSE** janë më pak të shpejta por kanë izolim perfekt nga agjentet atmosferik, si uji, pluhuri apo zjarri. Modifikimi i vajit bazë përmirëson përballimin e temperaturës së lartë duke eliminuar zhurmen. Vajrat e rinj standard kanë dy here më shumë jetëgjatësi në temperaturë 120° C.

-55 +125

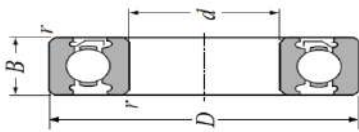

Kodi	Dimensionet në mm			Shpejtësia maksimale		Çmimi	
	d	D	B	ZZE (Metalik)	2NSE (Plastik)	ZZE (Metalik)	2NSE (Plastik)
6000	10	26		30000	22000		
6001	12	28	8	28000	18000		
6002	15	32	9	24000	15000		
6003	17	35	10	22000	14000		
6004	20	42	12	18000	11000		
6005	25	47	12	15000	9500		
6006	30	55	13	13000	8000		
6200	10	30	9	24000	17000		
6201	12	32	10	22000	17000		
6202	15	35	11	20000	15000		
6203	17	40	12	18000	12000		
6204	20	47	14	16000	11000		
6205	25	52	15	13000	9000		
6206	30	62	16	11000	7500		
6207	35	72	17	9800	6300		
6208	40	80	18	8700	5600		
6209	45	85	19	7800	5300		
6210	50	90	20	7100	4800		
6211	55	100	21	6400	4300		
6212	60	110	22	6000	3800		
6213	65	120	23	5500	3600		
6214	70	125	24	5100	3400		
6215	75	130	25	4800	3200		
6216	80	140	26	4500	3000		
6217	85	150	28	4300	2800		
6218	90	160	30	4000	2600		
6219	95	170	32	3800	2600		
6220	100	180	34	3600	2400		
6300	10	35	11	21000	1700		
6301	12	37	12	20000	16000		
6302	15	42	13	17000	13000		
6303	17	47	14	16000	11000		
6304	20	52	15	14000	10000		
6305	25	62	17	12000	8100		
6306	30	72	19	10000	6700		
6307	35	80	21	8800	6000		
6308	40	90	23	7800	5300		
6309	45	100	25	7000	4800		
6310	50	110	27	6400	4300		
6311	55	120	29	5800	4000		
6312	60	130	31	5400	3600		
6313	65	140	33	4900	3400		
6314	70	150	35	4600	3200		
6315	75	160	37	4300	2900		

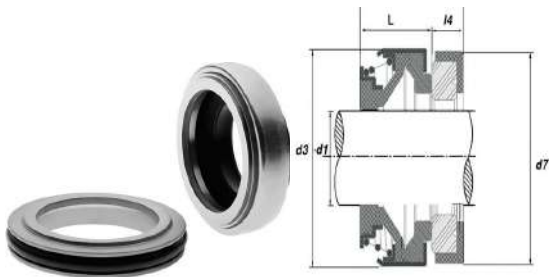
Permistop AT

Aksi	Pjesa Rrotulluese		Unaza e palëvizshme		Kodi	Çmimi
	D1	d3	L	d7		
12	24	13	13	8	AT12	
13	24	11.5	11.5	8	AT13	
14	28	13	13	8	AT14	
15	28	13	13	8	AT15	
16	32	13	13	8	AT16	
17	39	13	13	8	AT17	
18	39	13	13	8	AT18	
19	39	13	13	8	AT19	

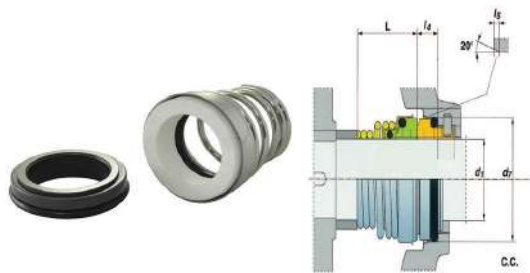
Permistop FN, konik

Aksi	Pjesa Rrotulluese		Unaza e palëvizshme		Kodi	Çmimi
	D1	L	d7	I4		
12	18	20.6	5.5	FN12		
13	22	23.1	6	FN13		
14	22	23.1	6	FN14		
15	22	26.9	7	FN15		
16	23	26.9	7	FN16		
17	23	26.9	7	FN17		
18	24	30.9	8	FN18		
19	25	30.9	8	FN19		
20	25	30.9	8	FN20		
22	25	35.4	8	FN22		
24	27	35.4	8	FN24		
25	27	38.2	8.5	FN25		

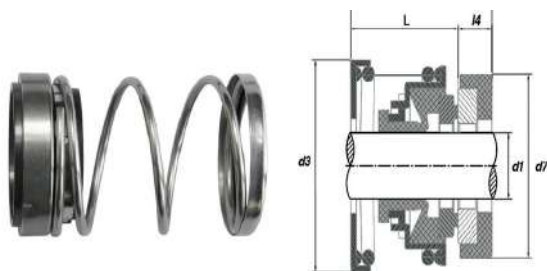
Permistop CL, cilindrik

Aksi	Pjesa Rrotulluese		Unaza e palëvizshme		Kodi	Çmimi
	d1	d3	L	d7		
15	31.5	24	29.5	8	CL15	
16	31.5	24	29.5	8	CL16	

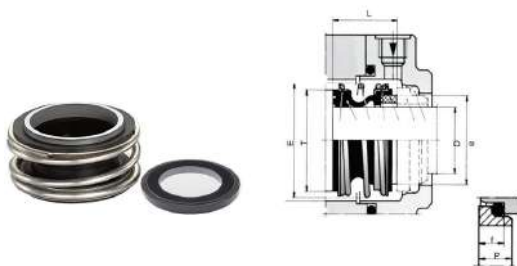
Permistop CL, cilindrik

Aksi	Pjesa Rrotulluese		Unaza e palëvizshme		Kodi	Çmimi
	d1	d3	L	d7		
16	32	17	27	6.5	G6016	
18	37	19.5	33	7.5	G6018	
20	37	21.5	35	7.5	G6020	
22	42.5	21.5	37	7.5	G6022	
24	42.5	22.5	39	7.5	G6024	
25	49	23	40	7.5	G6025	
28	49	26.5	43	7.5	G6028	
30	53.5	26.5	45	7.5	G6030	
32	53.5	27.5	48	7.5	G6032	
33	57	27.5	48	7.5	G6033	
35	59	28.5	50	7.5	G6035	
38	62	30	56	9	G6038	

Helikë freskimi F1

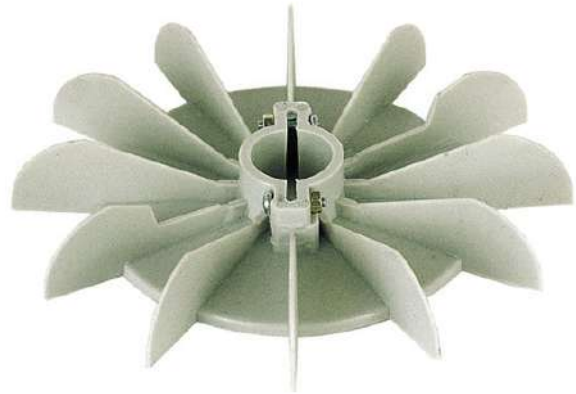
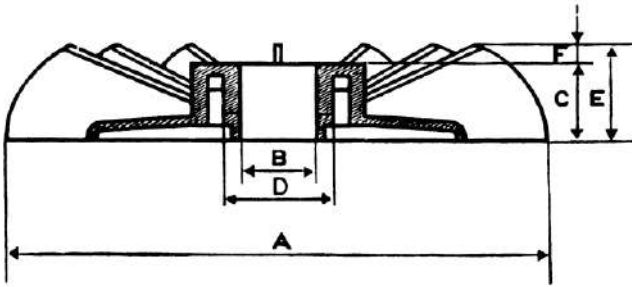

A	B	C	D	E	F	Kodi	Çmimi
100	12	20	18	19	-	HLV71	
118	15	21	21	23	2	HLV72	
132	14	21	20	25	4	HLV73	
149	19	24	27	27	3	HLV74	
163	24	26	31	28	2	HLV75	
187	28	25	35	31	6	HLV76	
202	28	28	35	34	6	HLV78	

Helikë freskimi F2

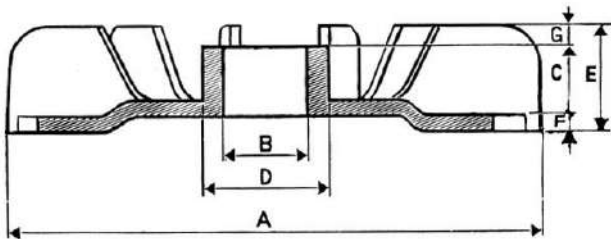

A	B	C	D	E	F	G	Kodi	Çmimi
104	14	12	23	19	2	5	HLV101	
122	15	14	24	21	1	5	HLV102	
135	19	16	29	24	1	7	HLV103	
159	25	20	36	28	2	6	HLV104	
175	29	21	39	30	5	3	HLV105	
195	30	25	44	32	2	5	HLV106	
235	34	32	50	36	3	1	HLV109	
235	39	32	50	36	3	1	HLV107	

Helikë freskimi F3

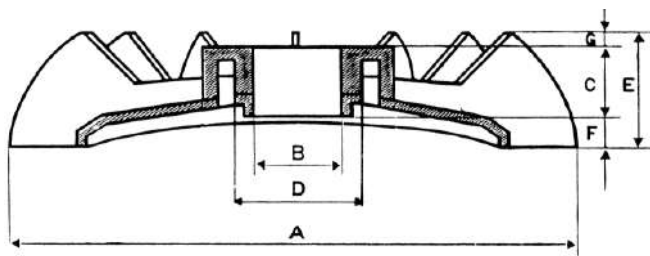

A	B	C	D	E	F	G	Kodi	Çmimi
115	14	15	20	24	6	3	HLV111	
130	15	17	20	29	7	5	HLV112	
142	19	20	26	29	6	3	HLV113	
169	24	23	30	32	7	3	HLV114	
178	28	23	34	33	4	6	HLV115	
205	28	25	35	36	6	5	HLV116	
236	35	30	45	48	13	6	HLV120	
236	38	30	45	48	13	6	HLV117	
290	45	33	52	53	13	7	HLV118	
332	50	34	27	59	18	8	HLV119	

Helikë freskimi F4

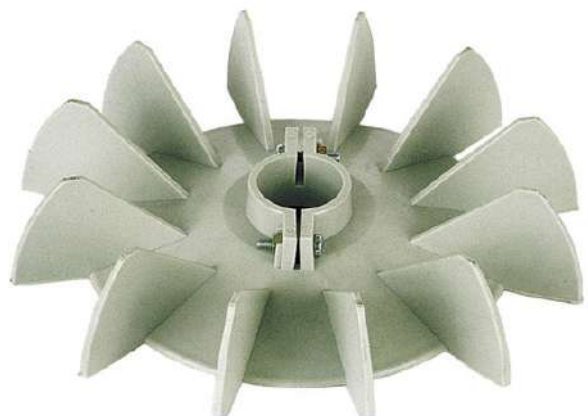
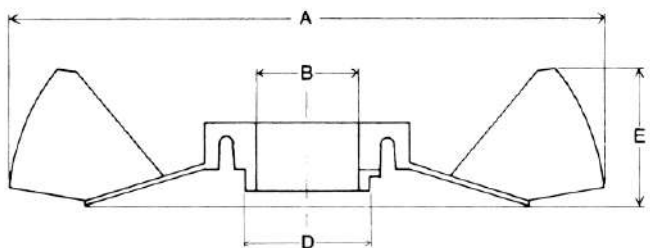

A	B	C	D	E	Kodi	Çmimi
112	15	19	25	25	HLV205	
134	19	23	29	29	HLV207	
144	23	28	34	34	HLV209	
167	28	33	38	38	HLV211	
185	28	33	41	41	HLV213	

www.albbaker.com

UNI-T®

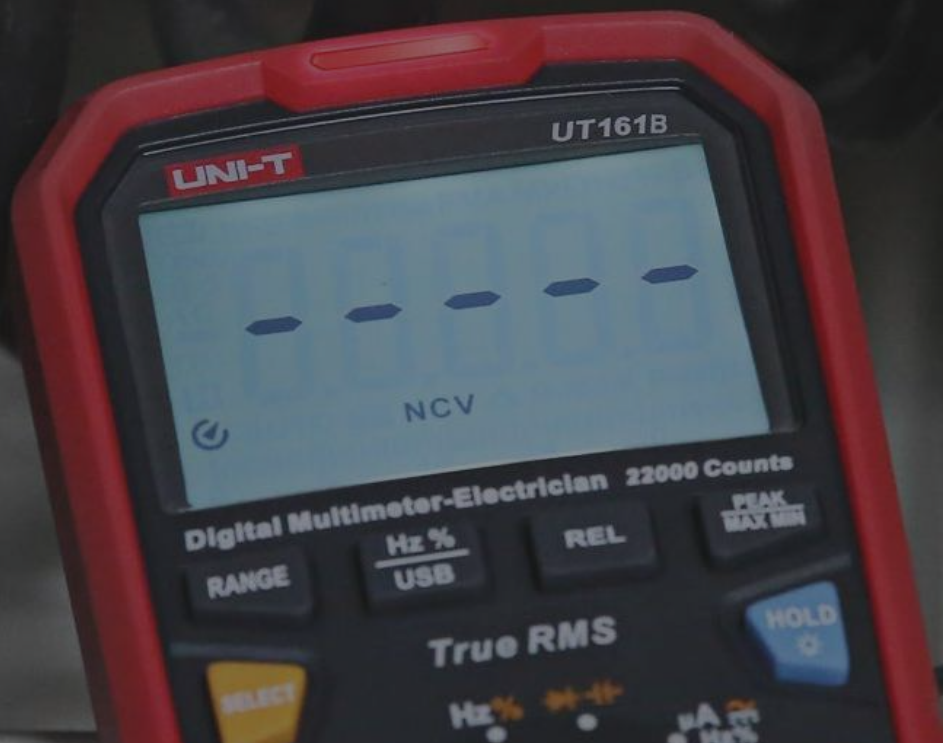

18

LINJA E PRODUKTEVE UNI-T

UNI-T

Detektorë voltazhi

SPECIFIKIME	UT12S	UT12D	UT12E	UT12M
Voltazhi AC (i ulet)	90V~1000V	24V~1000V	24V~1000V	24V~1000V
Voltazhi AC (i larte)	90V~1000V	90V~1000V	90V~1000V	90V~1000V
Frekuenca	50/60Hz	50/60Hz	50/60Hz	50/60Hz
Lloji me dridhje			√	
Detektimi magnetik				√
Derdhje me injektim te dyfishte			√	√
Testi i renies	1m	1m	2m	2m
Cmimi				

UNI-T

Detektorë voltazhi dhe vazhdimësie

MODELET	UT22B-EU	UT15C	UT18D	UT18E
INDIKIMI LED I VOLTASHIT	12V 24V 50V 120V 230V 400V	12V 24V 50V 120V 230V 400V 690V	6V 12V 24V 50V 120V 230V 400V 690V	6V 12V 24V 50V 120V 230V 400V 690V 1000V
Testi i renditjes së fazëve		√	√	√
Detektimi i polaritetit		√	√	√
Testi i vazhdimësisë 0-100kΩ		√	√	√ (0-60kΩ)
RCD test Operon ne voltazh 230v		√	√	√
Flashlight		√	√	√
Modalitet silent		√	√	√
Mbrojtja IP	IP54	IP65	IP65	-
Bateria	IP54 Nuk ka nevojë, merr energji nga voltazhi	1.5V AAA x 2	1.5V AAA x 2	1.5V AAA x 2
Cmimi				

Multimetra të madhësisë së dorës UT33+/UT131

UNI-T

SPECIFIKIME	UT33A+	UT131A	UT33B+	UT131B
Certifikime CE, UKCA, cETLus				
Voltazhi DC	600V/250V	√ 600V/250V	600V/250V	√ 600V/250V
Voltazhi AC	600V/250V	√ 600V/250V	600V/250V	√ 600V/250V
Rryma DC	10A	√ 10A	10A	√ 10A
Rryma AC	10A	√ 10A	10A	√ 10A
Rezistenca	200MΩ	√ 20MΩ	20MΩ	√ 200MΩ
Kapacitor	2mF	√ 2mF	2000	√ 2000
Numerimi	2000	√ 2000	2000	√ 2000
Diode/Vazhdimesi	√	√	√	√
Fikje automatike	√	√	√	√
Modaliteti relativ	√	√	√	√
Auto Range	√	√	√	√
Testi i renies	1m	√ 1m	1m	√ 1m
Cmimi				

Multimetra digjitalë

UNI-T

SPECIFIKIME	UT39A+	UT39C+	UT39E+	UT106
Voltazhi DC	1000V	√ 1000V	1000V	√ 200V
Voltazhi AC	750V	√ 750V	1000V	√ 200V/750V
Rryma DC	10A	√ 10A	20A	√ 10A
Rryma AC	10A	√ 10A	20A	√ 10A
Rezistenca	200MΩ	√ 40MΩ	200MΩ	√ 20MΩ
Kapacitor	10mF	√ 10mF	2000μF	√ 2000
Frekuenca		√ 1MHz	2MHz	√ 2kHz
Temperatura		√ -40°C~1000°C	-40°C~1000°C	√ -40°C~1000°C
Numerimi	4000	√ 4000	20000	√ 2000
Diode/Vazhdimesi	√	√	√	√
Fikje automatike	√	√	√	√
Cmimi				

SPECIFIKIME	UT123	UT123T	UT125C	UT60S
Certifikime CE, UKCA, cETLus	✓	✓	✓	✓
Voltazhi DC	600V	600V	600V	1000V
Voltazhi AC	600V	600V	600V	1000V
Rryma DC	10A	10A	400mA	10A
Rryma AC	10A	10A	400mA	10A
Rezistenca	20MΩ	20MΩ	40MΩ	100MΩ
Kapacitor			100μF	10000μF
Frekuenca			60kHz	10MHz
Temperatura	-40°C~300°C	-40°C~300°C		-40°C~1000°C
Fikje automatike	✓	✓	✓	✓
Modaliteti relativ				✓
Auto Range	✓	✓	✓	✓
Testi i renies	1m	1m	1m	1m
Cmimi				

SPECIFIKIME	UT139A	UT139B	UT139C	UT139S
Certifikime CE, cETLus	✓	✓	✓	✓
Voltazhi DC	600V	600V	600V	600V
Voltazhi AC	600V	600V	600V	600V
Rryma DC	10A	10A	10A	10A
Rryma AC	10A	10A	10A	10A
Rezistenca	20MΩ	40MΩ	60MΩ	60MΩ
Kapacitor		10000μF	100000μF	100000μF
Frekuenca		10MHz	10MHz	10MHz
Temperatura			-40°C~1000°C	-40°C~1000°C
VFC	✓	✓	✓	
LoZ				✓
Diode/vazhdimesi	✓	✓	✓	✓
Fikje Automatike	✓	✓	✓	✓
Cmimi				

Multimetra digjitalë

UNI-T

SPECIFIKIME	UT15B MAX	UT17B PRO	UT17B MAX	UT18B PRO
Certifikime CE, UKCA, cETLus		✓	✓	✓
Voltazhi DC	1000V	1000V	1000V	1000V
Voltazhi AC	1000V	1000V	1000V	1000V
Rryma DC	10A	10A	10A	10A
Rryma AC	10A	10A	10A	10A
Rezistenca	60MΩ	60MΩ	60MΩ	60MΩ
Kapacitor	6000μF	6000μF	6000μF	6000μF
Frekuenca	10Hz~10MHz	100KHz	10Hz~10MHz	1MHz
Temperatura		-55°C~500°C	-55°C~500°C	-55°C~500°C
Fikje automatike	✓	✓	✓	✓
Modaliteti relativ	✓	✓	✓	✓
Auto Range	Auto/Manual	✓	Auto/Manual	✓
Testi i renies		1m		1m
Cmimi				

Multimetra digjitalë

UNI-T

SPECIFIKIME	UT61B+	UT61E+	UT161B	UT161D
Certifikime CE, RoHS, cETLus			✓	✓
Voltazhi DC	1000V	1000V	1000V	1000V
Voltazhi AC	1000V	1000V	1000V	1000V
Rryma DC	10A	20A	10A	20A
Rryma AC	10A	20A	10A	20A
Rezistenca	60MΩ	220MΩ	60MΩ	60MΩ
Kapacitor	60000μF	220000μF	60000μF	60000μF
Frekuenca	10MHz	2200MHz	10MHz	10MHz
Temperatura				-40°C~1000°C
NCV	✓	✓	✓	✓
LoZ				✓
Diode/vazhdimesi	✓	✓	✓	✓
Fikje Automatike	✓	✓	✓	✓
Cmimi				

SPECIFIKIME	UT161E	UT117C	UT195DS	UT196
				
Certifikime CE	✓	✓	✓	✓
Voltazhi DC	1000V	600V	1000V	1700V
Voltazhi AC	1000V	600V	1000V	1500V
Rryma DC	20A	10A	20A	
Rryma AC	20A	10A	20A	
Rezistenca	220MΩ	40MΩ	60MΩ	60MΩ
Kapacitor	220000μF	9999uF	60000μF	60000μF
Frekuenca	220MHz	50.00KHz	40MHz	1MHz
Temperatura				
AC+DC	✓		✓	✓
VFC				
LoZ		✓	✓	✓
Diode/vazhdimesi	✓	✓	✓	✓
Fikje Automatikë	✓	✓	✓	✓
Cmimi				

SPECIFIKIME	UT601	UT603	UT612 LCR Metër
			
Certifikime CE	✓	✓	✓
Rezistenca (Ω)	20Ω - 20MΩ	20Ω - 20MΩ	20Ω~200MΩ
Kapacitor (F)	200pF - 600uF	200pF - 600uF	200pF - 20mF
Induktance (H)	2mH/20mH/200mH/2H/20H	2mH/20mH/200mH/2H/20H	20uH - 2000H
Frekuenca e testit	-	-	100Hz-100kHz
Voltazhi i operimit			0.6Vrms
Numerimi ne ekran	2000	2000	20000
Auto Range	-	-	✓
Cmimi			

SPECIFIKIME	UT200B+	UT202A+	UT202BT+	UT204R
Certifikime CE				√
Voltazhi DC	600A	600V	600A	600A
Voltazhi AC	600A	600V	600A	600A
Rryma DC				600A
Rryma AC	600A	600A	600A	600A
Rezistenca	3MΩ	60MΩ	1000MΩ	60MΩ
Kapacitor	1000μF	60000μF	100mF	60000μF
Frekuenca	10kHz	10MHz	40-1000Hz	10MHz
Temperatura			-40°C~1000°C	-40°C~1000°C
Madhesia e hapjes	28mm	28mm	28mm	28mm
Numerimi ne ekran	3099	6000	9999	6000
Diode/vazhdimesi	√	√		√
Drite ndricuese	√		√	
Bluetooth			√	
Cmimi				

SPECIFIKIME	UT207B	UT219DS	UT219P	UT222
Certifikime CE/UKCA/cETLus	√	√	√	√
Voltazhi DC	1000V	1000V	-	1000V
Voltazhi AC	1000V	1000V	1000V	1000V
Rryma DC	1000A	600A	-	2500A
Rryma AC	1000A	600A	1000 A	2500A
ACA Frekuencë (Hz)	-	-	40Hz~1kHz	-
Rezistenca	60MΩ	60MΩ	-	60MΩ
Kapacitor	60000μF	60000μF	-	60000μF
Frekuenca	1MHz	40MHz	15Hz~1000Hz	60MHz
Temperatura		-40°C~1000°C	-40°C~1000°C	-40°C~1000°C
Madhesia e hapjes (diametri i nollulles)	42mm	33mm	75mm	63mm
LoZ	√	√	√	-
Diode/vazhdimesi	√	√	√	√
Fikje Automatikë	√	√	√	√
Fuqia (një fazë)	-	-	1000KW	-
Fuqia (3 fazë & 3 tela)	-	-	1732KW	-
Fuqia (3 fazë & 4 tela)	-	-	3000KW	-
Këndi i fazës (-180°~179.9°)	-	-	15Hz~40Hz 40Hz~70Hz 70Hz~1000Hz	-

SPECIFIKIME	Range	UT521	UT522	UT572
Certifikime CE		√	√	√
Rezistenca e tokës (Ω)	4Ω			±(3%+15)
	0~20Ω	±(2%+10)		
	0~200Ω	±(2%+3)		
	0~2000Ω	±(2%+3)		±(3%+5)
	0~40Ω		±(2%+20)	±(3%+5)
Voltazhi AC i tokës (V)	0~400Ω		±(2%+3)	±(3%+5)
	0~4000Ω		±(2%+3)	±(3%+5)
	0~40000Ω			±(3%+5)
	0~200V	±(1%+4)		±(3%+5)
	0~400V		±(1%+6)	
Frekuenca	50Hz/60Hz	√	√	
Disturbance voltage (Ust)	50V DC			±(3%+3)
Disturbance frequency (Fst)	40Hz~500Hz			±(1%+2)
Cmimi	Cmimi			

SPECIFIKIME	UT276A+	UT278A+	UT278C	UT278D
Certifikime CE/RoHS	√	√		
Rezistenca e tokës	0.01~590Ω	0.01~1200Ω	0.00Ω~1800Ω	0.00Ω~2000Ω
Rryma AC		0.000A~20A	0.000A~50A	0.000A~60A
Rezolucioni i rrymës		1mA	1mA	1mA
Metoda e rezistencës 3/4 tela			0.00Ω~30KΩ	0.00Ω~30KΩ
Voltazhi i tokës			600V	600V
Matja e rrymës së rrjedhjes		√		
Madhesia e hapjes	32mm	32mm	68mm	68mm
Ekрани	LCD (EBTN)	LCD (EBTN)	LCD	LCD
Furnizimi me korrent	Bateri 1.5V x 4	Bateri 1.5V x 4	Bateri DC 3.7V	Bateri DC 3.7V
Alarm	√	√	√	√
Cmimi				

Testues rezistence dhe izolacioni

UNI-T

SPECIFIKIME	Range	UT505B	UT501A	UT501B	UT502A
Certifikime CE		√	√	√	√
100V	0.01MΩ~100MΩ 100MΩ~1GΩ 1GΩ~20GΩ	±(3%+3) ±(3%+3) ±(3%+3)	±(3%+5)		2500V
250V	0.01MΩ~100MΩ 200MΩ~5GΩ 1GΩ~50GΩ	±(3%+3) ±(3%+3) ±(3%+3)	±(3%+5) ±(5%+5)	±(3%+5) ±(5%+5)	
500V	0.01MΩ~100MΩ 200MΩ~5GΩ 1GΩ~50GΩ	±(3%+3) ±(3%+3) ±(3%+3)	±(3%+5) ±(5%+5)	±(3%+5) ±(5%+5)	±(3%+5) ±(5%+5)
1000V	0.1MΩ~2000MΩ 2GΩ~9.9GΩ 10GΩ~20GΩ 20GΩ~200GΩ	±(3%+3) ±(3%+3) ±(3%+3) ±(3%+3)	±(3%+5) ±(5%+5)	±(3%+5) ±(5%+5)	±(3%+5) ±(5%+5)
2500V	0MΩ~99.9MΩ 100MΩ~9.9GΩ 10GΩ~20GΩ				±(3%+5) ±(5%+5) ±(10%+5)
Voltazhi		50V-1000V	100V-1000V	100V-1000V	100V-1000V
Rryma vazhdimit	1mA	0%~10%	<2mA	<2mA	<2mA
Rryma e qarkut shkurtë		<2mA	<2mA	<2mA	<2mA
Voltazhi AC (V)		0V~600V	30V~600V	30V~750V	30V~750V
Numërimi në ekran		6000	2000	2000	2000
Cmimi					

Testues rezistence dhe izolacioni

UNI-T

SPECIFIKIME	Range	UT512	UT513A	Bluetooth UT513C	UT516B
Certifikime CE		√	√	√	
250V				0.25MΩ~250GΩ	
500V	0.5MΩ~5GΩ	±(5%+5)	±(5%+5)	0.50MΩ~500GΩ	0.50MΩ~500GΩ
1000V	0.5MΩ~20GΩ		±(5%+5)	1.00MΩ~1.00TΩ	1.00MΩ~1000GΩ
2500V	2MΩ~10GΩ	±(5%+5)	±(5%+5)	2.50MΩ~2.50TΩ	2.50MΩ~2.5TΩ
5000V	10MΩ~100GΩ		±(10%+5)	5.00MΩ~5.00TΩ	5.00MΩ~5.0TΩ
10000V					10.0MΩ~10TΩ
12000V					12.0MΩ~10TΩ
Voltazhi DC (V)	1000V	±(2%+3)	±(2%+5)	30~1000VDC	30V~1000V
	600V		±(2%+5)		
Voltazhi AC (V)	750V	±(2%+3)	±(2%+5)	30~750VAC	30V~750V
	600V		±(2%+5)		
Cmimi					

SPECIFIKIME	UTP3303-II	UTP3315TFL-II
Lloji	DC Linear	DC Linear
Channels	3	1
Fuqia totale	207W	150W
Voltazhi output	32V	30V
Rryma output	3A	5A
Rezolucioni	10mV/1mA	10mV/1mA
Saktesia	Voltazhi:<0.01%+3mV Rryma:<0.2%+3mA	Voltazhi:<0.01%+3mV Rryma:<0.1%+3mA

Cmimi



Seria **UTP3315TFL-II** është një furnizues ekonomik linear me energji DC me cilësi të shkëlqyeshme dhe tregues të shkëlqyeshëm, me tension LED intuitiv katër-bit, ekran aktual, mbingarkesë me qark të shkurtër, mbrojtje nga polariteti i kundërt dhe funksione të tjera.

Stabilitet i lartë dhe besueshmëri e lartë.



Seria **UTP3303-II** është furnizues linear me energji DC me tre kanale me dalje të dyfishtë të rregullueshme dhe dalje fikse me një kanal, me gjurmim, tension/rrymë konstante, dalje seri/paralele, temperaturë/ventilator ftohës i kontrolluar dhe mbrojtje ndaj tensionit/rrymës.



SPECIFIKIME	UT-CS09D
	
Certifikime CE/UKCA/cETLus	✓
Voltazhi DC	
Voltazhi AC	
Rryma DC	
Rryma AC	30A/300A/3000A
Rezistenca	
Kapacitor	
Frekuenca	45Hz~500Hz
Temperatura	
Madhesia e hapjes (diametri i nofullës)	170mm
LoZ	
Diode/vazhdimesi	
Fikje Automatike	
Cmimi	

SPECIFIKIME	UT-256B
	
Certifikime CE/UKCA/cETLus	✓
Voltazhi (V) DC	1000 V
Voltazhi (V) AC	750V
Rryma (A) DC	200A
Rryma (A) AC	200A
Rezistenca (Ω)	60 MΩ
Kapacitor (F)	60 000 uF
Frekuenca (Hz)	10H~10kHz
Numri matjeve	6000
Testi Diodes	✓
NCV	✓
Relative mode	✓
Zero mode	✓
Cmimi	

Mates distance me lazer

UNI-T

SPECIFIKIME	LM50A	LM70A	LM100A	LM120A
Certifikime CE,UKCA	✓	✓	✓	✓
Lloji i ekranit	TN	TN	TN	TN
Madhesia e LCD (inch)	2.0	2.0	2.0	2.0
Range (m)	50m	70m	100m	120m
Data storage	99 sete	99 sete	99 sete	99 sete
Njesia e matjes	m / ft / in / ' "	m / ft / in / ' "	m / ft / in / ' "	m / ft / in / ' "
Saktesia	±2mm	±2mm	±2mm	±2mm
Klasi i lazerit	2	2	2	2
Lloji i lazerit	630-670nm	630-670nm	630-670nm	630-670nm
Fikje automatike	✓	✓	✓	✓
Shfaqja e statusit te baterise	✓	✓	✓	✓
Lloji i baterise	2xAAA 1.5V	2xAAA 1.5V	2xAAA 1.5V	2xAAA 1.5V
Cmimi				

Nivelues lazer

UNI-T

SPECIFIKIME	LM570LD-II	LM573LD-II	LM575LD
CE/UKCA	✓	✓	✓
Lloji i lazerit	LD Jeshil	LD Jeshil	LD Jeshil
Vala e lazerit	520nm	520nm	520nm
Klasi i lazerit	Class II	Class II	Class II
Linjat e lazerit	1V1H	3D 12 lines	3D 12 lines
Saktesia e lazerit	<±3mm/10m	±3mm/10m	±3mm/10m
Montim ne mur		✓	
Pult komandimi		✓	
Distanca e operimit	10m	40m	40m
Kapaciteti i baterise	2x 1.5V LR6 AA	5200mAh type c	5200mAh type c
Oret e punes	4h	>6h	>6h
Cmimi			

UNI-T

Dedektues dhe Testues kabëlli dhe Lan-i

SPECIFIKIME

- Certifikime CE/RoHS
- Ushqyesi
- Gjurmimi i kabullit
- NCV
- Ndricues per erresire
- Indikim i baterise se ulet
- Input per kufje
- Testim i polaritetit
- Testim i vazhdimesise
- Fikje automatike
- Cmimi

UT682

- √
- Bateri 9V
- √

UT682D

- √
- Bateri 9V
- √

UT683KIT

- √
- 1050mAh
- √
- √
- √
- √
- √
- √

UNI-T

Testues TDR kabëlli

SPECIFIKIME

- Certifikime CE/RoHS
- Ushqyesi
- Gjatësia e kabullit
- Mbrojtje inputi
- Ndricues per erresire
- Indikim i baterise se ulet
- Ekrani
- Vendndodhje e kabullit
- Test i ethernet port
- Fikje automatike
- Cmimi

UT685B KIT

- √
- 4xAAA Bateri
- 500m
- 70V DC
- √
- √
- 2.8" LCD
- √
- √
- √

Testues kabëlli interneti dhe HMDi-je

UNI-T

SPECIFIKIME	UT681L	UT681C	UT681HDMI
CE	✓	✓	✓
Test RJ45/RJ11	✓		
Test RJ45/RJ11/BNC		✓	
Test HDMI/MINI-HDMI			✓
Fast test mode	✓	✓	
Slow test mode	✓	✓	
Scan test mode			✓
Testim i qarkut të shkurtër, të hapur	✓	✓	✓
Funksion i fikjes manuale	✓	✓	✓
Funksion i fikjes automatike	✓	✓	✓
Ushqyes rryme: Bateri 9V	✓	✓	✓
Temperatura punës: 0°C~40°C	✓	✓	✓
Lagështia e punës 20~80%RH	✓	✓	✓
Cmimi			

Testues multimeter kabëlli për fibër optike

UNI-T

SPECIFIKIME	UT691-01 Lokalizues	UT692D Multimeter optikal	UT693D Multimeter optikal
CE/UKCA	✓	✓	✓
Gjatesia e vales	630~670nm	800nm~1700nm	650nm±10nm
Bateria	1050mAh	Bateri 1.5V (LR6) x 3	Bateri 1.5V (LR6) x 3
Indikim i baterise se ulet	✓	✓	✓
Cmimi			



Micro Ohm meter te serise UT620

SPECIFIKIME	RANGE	UT620A	UT620B
Rezolucion		√	√
Resistance (Ω)	60mΩ/10A	√	±(0.25%+25)
	120mΩ/5A	±(0.25%+25)	±(0.25%+20)
	600mΩ/1A	±(0.25%+25)	±(0.25%+20)
	6Ω/100mA	±(0.25%+25)	±(0.25%+20)
	60Ω/10mA	±(0.25%+25)	±(0.25%+20)
	600Ω/1mA	±(0.25%+25)	±(0.25%+20)
	6kΩ/100uA	±(0.75%+30)	±(0.25%+30)
Numerimi	√	√	√
Data Storage		60000	60000
Cmimi		1000	1000

UT620A përdoret për të matur rezistencën e ulët DC përmes metodës me 4 tela. Karakteristikat e tij janë: Funkzioni i krahasimit për të përcaktuar nëse pajisja është në gjendje të mirë, llogaritja e gjatësisë së telit të panjohur (FT/M); transmetim i dyanshëm i të dhënave me ndërfaqe USB.

Oshilometer dore UTD1025CL

SPECIFIKIME	UTD1025CL
Bandwidth	25MHz
Voltazhi AC (V)	400V
Voltazhi DC (V)	400V
Rryma AC (A)	400μA/ 4000μA
	40mA/ 4000mA
Rryma DC (A)	400μA/ 4000μA
	40mA/ 4000mA
Resistance (Ω)	400Ω/4kΩ/40kΩ/400kΩ/4MΩ
	40MΩ
Kapacitor	100μF
Numerimi	4000
Ushqimi	Li-ion battery: 7.4V 3600mAh; DC adapter: 100V~240V 50/60Hz input
Ekran	3.5 inches 64k TFT LCD, 320 x 240
Interface	Mini USB
Cmimi	

Seritë UTD1025L janë instrumente ekonomike me funksionin e oshiloskopit dhe multimetrit. Ato janë instrumente ergonomike, të lehta, universale të dizajnuara për inxhinierë.

Testues diferencial (Salvavite) digjitale RCD

SPECIFIKIME	UT582+
X 1/2	10mA/20mA/30mA/100mA/300mA/500mA
X 1	10mA/20mA/30mA/100mA/300mA/500mA
X 5	10mA/20mA/30mA
Auto ramp	10mA/20mA/30mA/100mA/300mA/500mA
Saktësia	±(3%+3)
Voltazhi i operimit	195V~253V
Range voltazhi	30~600V
Frekuencë	45Hz~65H
Rezolucion	1V
Numërimi	1000
Cmimi	



UT582+ përdoret kryesisht për të zbuluar nëse RCD në qark mund të aktivizohet normalisht. Është i përshtatshëm vetëm për qarqet njëfazore me diapazonin e tensionit të furnizimit prej 195V~253V. Gama e tij e matjes së tensionit është 30V~600V.



Termometra infrarede digjitale

UNI-T

SPECIFIKIME	UT300A+	UT301C+	UT302C+
			
Temperatura	-20°C~400°C	-32°C~600°C	-32°C~1100°C
Saktësia	>0°C:±2.0°C or ±2%; ≤0°C:±(2.0°C+0.1°C/°C)	>0°C: ±1.5°C or ±1.5%; ≤0°C: ±(1.5°C+0.1°C/°C)	≥0°C: ±1.5°C or ±1.5%; <0°C: ±(1.5°C+0.1°C/°C)
Perseritja	1°Cor1.0%(2°Cor1.0%)	0.7°Cor0.7%(1.5°Cor0.7%)	0.7°Cor0.7%(1.5°Cor0.7%)
Raporti D:S	10:1	12:1 (95%)	20:1
Koha reagimit	≤500ms (95% e leximit)	≤250ms (95% e leximit)	250ms
Emetimi	0.95	0.1~1.0	√
Spektri	5.5um~14um	8um~14um	0.1um~1.0um
Fuqia Lazer	< 1mW	< 1mW	< 1mW
Fikje Automat	√	8s	√
Cmimi			

Kamera Termike me rezolucion të lartë

UNI-T

	UTi260B Kamera Termike	UTi730E Kamera Termike	
	Rezolucioni IR (Pixel) 256×192	Rezolucioni IR (Pixel) 320×240	
	Ekrani 2.8" TFT LCD	Ekrani 3.5" IPS	
	Field of view(FOV) 56°×42°	Field of view(FOV) 56°×42°	
	Sensitiviteti Termal ≤60mK	Sensitiviteti Termal ≤65mK	
	Rezolucioni Spacial 3.8mrad	Rezolucioni Spacial 3mrad	
	Frame rate ≤25Hz	Frame rate ≤9Hz	
	Spektri 8~14μm	Spektri 8~14μm	
	Temperatura e matjes -20°C~550°C	Temperatura e matjes -40°C~400°C	
	Saktësia ±2°C or ±2%	Saktësia ±2°C or ±2%	
	Emetimi 0.01~1.00	Emetimi 0.01~1.00	
	Çmimi	Çmimi	



UNI-T

Tachometra digjital (matës rrotullimesh) me infra red

SPECIFIKIME

CE
 Matje RPM
 Numerimi
 Refresh rate
 Lloji i sensorit
 Distanca e targetit
 Kendi i matjes
 Rezistent ndaj hedhjes
 Cmimi

UT371

✓
 10-99999RPM ± 0.03
 0~9999
 1s deri 7s

UT372

✓
 10-99999RPM ± 0.03
 0~9999
 1s deri 7s

UT373

✓
 10-99999RPM ± 0.03
 0~9999
 1s deri 7s
 Fotodiode dhe lazer
 50mm~200mm
 $\pm 30^\circ$
 1m

UNI-T

Matës të sekuençës së fazës dhe sensit të rrotullimit të motorrit

SPECIFIKIME

CE
 Voltazhi AC (V)
 Frekuenca
 Rryma e punës (A)
 Temperatura e operimit
 Temperatura e ruajtjes
 Lagështia e operimit
 Intensiteti i izolimit
 Niveli buzzerit
 Sekuenca e fazës
 Mungesa e fazës
 Rrrotillimi i motorit
 Cmimi

UT261A

✓
 90V-600V
 15Hz-400Hz
 <1mA

UT261B

✓
 40V-600V
 15Hz-400Hz
 <3mA

UT261E

✓
 70V-1000V AC 3 FAZ
 46Hz-66Hz
 0°C deri 50°C
 -20°C deri 60°C
 <85% (jo-kondens)
 3.7kVrms
 65-70dB
 $\pm 30^\circ$



LM320B Matës këndi lazer

Gama e matjes	4 x 90°
Saktësia	± 0.2°
Rezolucioni	0.01°
Specifika	Dual Lazer USB Type C

Çmimi



UT387E Skanues muri

Metale hekuri	40mm
Metale te tjera	80mm
Thellesia e kabullit AC	40mm
Druri	38mm

Çmimi



UT377A Matës lagështije druri

Lageshtia	2~40%
Temperatura operimit	0°C~40°C
Rezolucio	0.1%
Specifikime	Dual Lazer USB Type C

Çmimi



UT381 Matës te luksit të dritës

Iluminimi LUX	20 Lux~20000 Lux
Iluminimi Fc	2 Fc~2000 Fc
Numerimi	2000
Sampling	100/s

Çmimi



UT07A Socket tester

Voltazhi	230V
Rryma	<18mA
Frekuenca	50Hz~60Hz
RCD	Nuk ka
Çmimi	

UT07B Socket tester

Voltazhi	230V
Rryma	<18mA
Frekuenca	50Hz~60Hz
RCD	~30mA
Çmimi	



UT230B Power Socket

Voltazhi	100V~260V
Rryma	0A~16A
Frekuenca	45Hz~65Hz
Fuqia	1~3680W
Çmimi	

A25D Monitorues i kualitetit ajrit

Saktesia e matjes	PM 2.5 $\mu\text{g}/\text{m}^3$ 0~100 $\pm 10\% + 10\text{dgts}$ 101~400 $\pm 10\% + 30\text{dgts}$ 401~500 $\pm 10\% + 50\text{dgts}$
Temperatura	0~2mg/m ³ $\pm 1^\circ\text{C}$
Fuqia	5%~99%RH $\pm 5\% \text{RH}$ @ 30%~80%RH $\pm 8\% \text{RH}$ RH @ <30%RH, >80%RH
Çmimi	

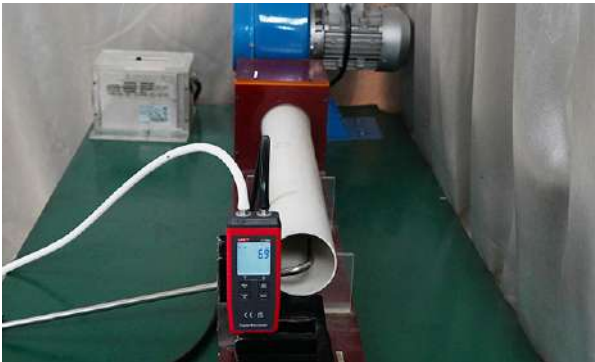



UT366A Manometer

Saktësia	±0.5% FS@25°C
Matje presioni	✓
Shpejtësia e erez	✓
Presioni P1/P2	✓
Çmimi	



UT673A Testues Baterie

12V battery test	7~16V DC
12V/24V crank test	7~30V DC
12V/24V charge test	7~30V DC
Kapaciteti i baterisë	3~250Ah
Çmimi	

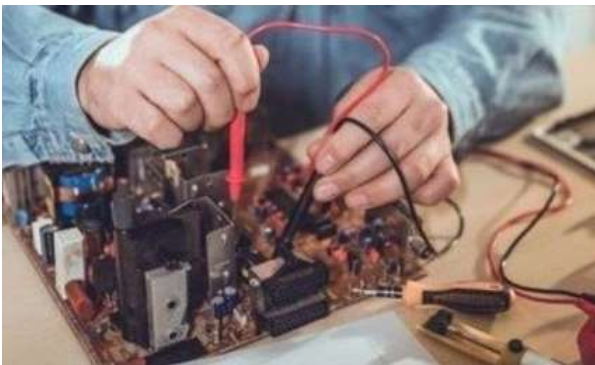

Fisha	UT-L21	UT-L26
Gjatesia plumbit	900mm	900mm
Gjatesia shufres	133mm	136mm
Gjatesia majes	15.8mm	15.7mm
Voltazhi	20A	20A
Çmimi		



Fisha UT-L33

Gjatesia totale	1200±20mm
Aplikimi	UT511
Material	Izolim dopio UL
Voltazhi	10A
Çmimi	





Ne jemi gjithmonë të hapur për bashkëpunime dhe lidhje të reja në fushën e materialeve dhe aparatave elektrike industriale. Ne vlerësojmë inovacionin dhe njohuritë e reja, dhe jemi të gatshëm të eksplorojmë mundësitë e bashkëpunimit me kompani dhe profesionistë të tjerë në treg.

Ju inkurajojmë të na kontaktoni nëse keni projekte, produkte, ose ide inovative që mendoni se mund të pasqyrojnë vizionin tonë të larmishmërisë dhe cilësisë. Jemi të hapur për diskutime dhe mundësi të reja të biznesit që mund të sjellin avantazhe reciproke.

AlbBakër pret me padurim të dëgjojë nga ju dhe të ndajë një rrugëtim të suksesshëm bashkë me partnerët e rinj të biznesit.

Kontaktoni sot dhe bëhuni pjesë e një rrjeti të fuqishëm bashkëpunimi!



Design by Ghag Studio

Copyright © [2024] AlbBakër. All rights reserved.



“

*Fgjedhja më e sigurtë
për nevojat tuaja*

”



www.albbaker.com
info@albbaker.com
+355 69 292 9800

