

**Kapikorda industriale ekonomike**

Seksioni mm <sup>2</sup>	Ø Vrima	d	D	l1	L	B	Kodi	Çmimi
16 mm <sup>2</sup>	M10	6	16	41	82	24	SKP-BM 16-10	
25 mm <sup>2</sup>	M10	7	16	41	82	24	SKP-BM 25-10	
35 mm <sup>2</sup>	M10	8.5	16	41	82	24	SKP-BM 35-10	
50 mm <sup>2</sup>	M12	9.8	20	49	90	25	SKP-BM 50-12	
70 mm <sup>2</sup>	M12	11.6	20	49	90	25	SKP-BM 70-12	
95 mm <sup>2</sup>	M12	13.8	20	49	90	25	SKP-BM 95-12	
120 mm <sup>2</sup>	M12	15.5	25	60	113	28	SKP-BM 120-	
150 mm <sup>2</sup>	M12	17	25	60	113	28	12SKP-BM 150-	
185 mm <sup>2</sup>	M12	18.5	32	65	130	35	12SKP-BM 185-	
240 mm <sup>2</sup>	M12	21.5	32	65	130	35	12SKP-BM 240-	
300 mm <sup>2</sup>	M12	24	34	70.8	135	36	12SKP-BM 300-	
400 mm <sup>2</sup>	M16	26	34	70.8	135	36	12SKP-BM 40-16	

**Bashkues kabulli industrial**

Seksioni mm <sup>2</sup>	D1	D2	L	Kodi	Çmimi
10	4.7	6.6	29	EK100047	
16	5.6	7.8	32	EK160056	
25	7.1	9.5	40.5	EK250071	
35	8.2	10.8	45.5	EK350082	
50	10.0	13.0	53.5	EK500100	
70	11.5	14.7	57.5	EK700115	
95	13.5	16.7	61.5	EK950135	
120	15.6	19.0	74.0	EK120156	
150	16.5	21.0	79.0	EK150165	
185	18.4	23.0	85.0	EK185184	
240	21.0	26.0	94.0	EK240210	

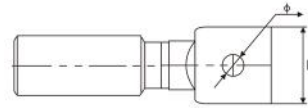
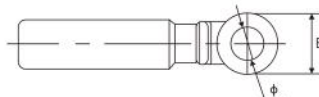
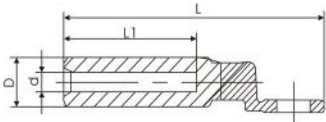
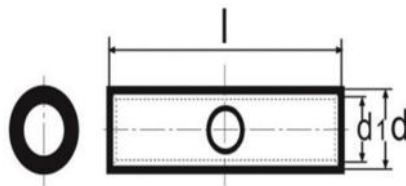
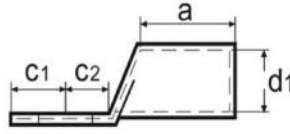
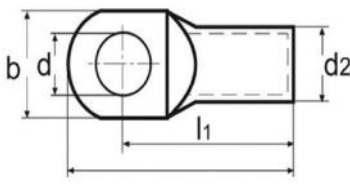

Seksioni mm <sup>2</sup>	Ø Vrima	d	d1	d2	l1	C1	a	b	Kodi	Çmimi
10	M5	5.5	4.7	6.0	21.6	6.0	10.0	10.3	SKPS010005	
	M6	6.5	4.7	6.0	21.6	6.0	10.0	10.3	SKPS010006	
	M8	8.5	4.7	6.0	21.6	6.0	10.0	13.5	SKPS010008	
16	M5	5.5	5.6	8.0	25	7.0	12.0	11.2	SKPS016005	
	M6	6.5	5.6	8.0	25	7.0	12.0	11.2	SKPS016006	
	M8	8.5	5.6	8.0	25	7.0	12.0	13.7	SKPS010008	
	M10	10.5	5.6	8.0	25	7.0	12.0	16.0	SKPS010010	
25	M6	6.5	6.8	9.0	32.2	6.8	16.0	13.5	SKPS025006	
	M8	8.5	6.8	9.0	32.2	6.8	16.0	13.5	SKPS025008	
	M10	10.5	7.0	9.5	34.0	6.8	16.0	16.0	SKPS025010	
35	M6	6.5	8.2	10.0	35.7	8.3	19.0	15.7	SKPS035006	
	M8	8.5	8.2	11.0	35.7	8.3	19.0	15.7	SKPS035008	
	M10	10.5	8.2	11.0	38.0	10.0	19.0	15.7	SKPS035010	
	M12	13.0	9.5	12.0	38.0	10.0	19.0	15.7	SKPS035012	
50	M6	6.5	8.2	12.0	39.2	8.3	21.0	17.7	SKPS050008	
	M8	8.5	9.5	12.0	39.2	8.3	21.0	17.7	SKPS050008	
	M10	10.5	9.5	12.0	41.5	10.0	21.0	17.7	SKPS050010	
	M12	13.0	10.1	13.0	41.5	10.0	21.0	19.0	SKPS050012	
70	M14	15.0	10.1	13.0	44.5	12.0	21.0	20.5	SKPS050014	
	M8	8.5	11.2	14.5	44.6	10.0	23.0	21.1	SKPS070008	
	M10	10.5	11.2	14.5	44.6	10.0	23.0	21.1	SKPS070010	
	M12	13.0	11.2	14.5	44.6	10.0	23.0	21.1	SKPS070012	
	M14	15.0	11.2	14.5	47.6	15.0	23.0	21.5	SKPS070014	
95	M16	17.0	11.2	14.5	47.6	15.0	23.0	21.5	SKPS070016	
	M8	8.5	13.4	17.0	48.8	10.0	26.0	24.5	SKPS095008	
	M10	10.5	13.4	17.0	48.8	10.0	26.0	24.5	SKPS095010	
	M12	13.0	13.4	17.0	48.8	10.0	26.0	24.5	SKPS095012	
120	M10	10.5	15.5	19.0	56.0	13.0	29.0	27.7	SKPS120010	
	M12	13.0	15.5	19.0	56.0	13.0	29.0	27.7	SKPS120012	
	M14	15.0	15.5	19.0	56.0	13.0	29.0	27.7	SKPS120014	
	M16	17.0	15.5	19.0	56.0	13.0	29.0	27.7	SKPS120016	
150	M10	10.5	16.5	21.0	60.0	16.5	30.0	30.4	SKPS150010	
	M12	13.0	16.5	21.0	60.0	16.5	30.0	30.4	SKPS150012	
	M14	15.0	16.5	21.0	60.0	16.5	30.0	30.4	SKPS150014	
185	M16	17.0	16.5	21.0	60.0	16.5	30.0	30.4	SKPS150016	
	M10	10.5	16.5	21.0	65.5	16.5	33.0	34.2	SKPS185010	
	M12	13.0	18.5	23.0	65.5	17.0	33.0	34.2	SKPS185012	
	M14	15.0	18.5	23.0	65.5	17.0	33.0	34.2	SKPS185014	
240	M16	17.0	18.5	23.0	65.5	17.0	33.0	34.2	SKPS185016	
	M10	10.5	21	26.0	72.0	17.0	38.0	38.7	SKPS240010	
	M12	13.0	21	26.0	72.0	17.0	38.0	38.7	SKPS240012	
	M14	15.0	21	26.0	72.0	17.0	38.0	38.7	SKPS240014	
	M16	17.0	21	26.0	72.0	17.0	38.0	38.7	SKPS240016	

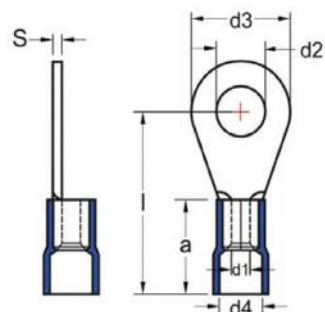
**Kapikorda unazë me veshje**

Ngjyra	Seksioni mm <sup>2</sup>	Ø Vrima	D3	L	D4	A	Paketimi	Kodi	Çmimi
●	0.5-1.5	4	4.3	17	4.0	10.0	200	GYU-401	
●	0.5-1.5	5	5.3	18	4.0	10.0	200	GYU-501	
●	0.5-1.5	6	6.5	18	4.0	10.0	200	GYU-601	
●	0.5-1.5	8	8.4	22	4.0	10.0	200	GYU-801	
●	1.5-2.5	4	4.3	17	4.5	10.0	200	GYU-402	
●	1.5-2.5	5	5.3	19	4.5	10.0	200	GYU-502	
●	1.5-2.5	6	6.5	21	4.5	10.0	200	GYU-602	
●	1.5-2.5	8	8.4	22	4.5	10.0	100	GYU-802	
●	4.0-6.0	5	5.3	21	6.3	13.0	100	GYU-506	
●	4.0-6.0	6	6.5	23	6.3	13.0	100	GYU-606	
●	4.0-6.0	8	8.4	26	6.3	13.0	100	GYU-806	
●	4.0-6.0	10	10.5	28	6.3	13.0	100	GYU-1006	
●	4.0-6.0	12	13.0	28	6.3	13.0	100	GYU-1206	

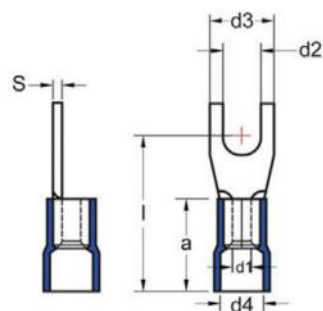
**Kapikorda pirun me veshje**

Ngjyra	Seksioni mm <sup>2</sup>	Ø Vrima	D3	L	D4	A	Paketimi	Kodi	Çmimi
●	0.5-1.5	4	4.3	17	4.0	10.0	200	GCU-401	
●	0.5-1.5	5	5.3	18	4.0	10.0	200	GCU-501	
●	0.5-1.5	6	6.5	18	4.0	10.0	200	GCU-601	
●	1.5-2.5	5	5.3	19	4.5	10.0	200	GCU-502	
●	1.5-2.5	6	6.5	21	4.5	10.0	200	GCU-602	
●	1.5-2.5	8	8.4	22	4.5	10.0	200	GCU-802	
●	4.0-6.0	5	5.3	21	6.3	13.0	100	GCU-506	
●	4.0-6.0	6	6.5	23	6.3	13.0	100	GCU-606	
●	4.0-6.0	8	8.4	26	6.3	13.0	100	GCU-806	

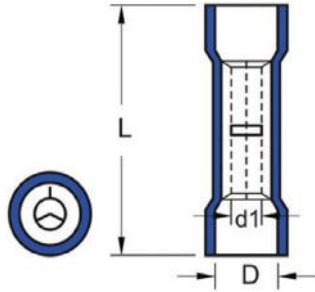
**Bashkues kabulli me veshje**

Ngjyra	Seksioni mm <sup>2</sup>	D	L	D1	Paketimi	Kodi	Çmimi
●	0.5-1.5	4.3	24.6	1.7	200	GBY-251	
●	1.5-2.5	5.3	24.6	2.3	200	GBY-252	
●	4.0-6.0	6.5	26.5	3.4	100	GBY-256	

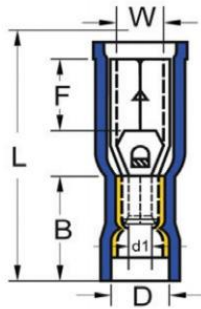
**Kapikorda femer kapuç me veshje**

Ngjyra	Seksioni mm <sup>2</sup>	W	F	L	B	D	Paketimi	Kodi	Çmimi
●	0.5-1.5	3.9	7	23.3	10.5	3.8	200	GBD-1040	
●	1.5-2.5	4.9	7	23.3	10.5	4.7	100	GBD-2050	
●	4.0-6.0	4.9	7	25.1	12.5	6.2	100	GBD-5050	

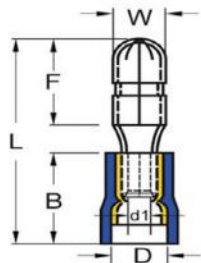
**Kapikorda mashkull kapuç me veshje**

Ngjyra	Seksioni mm <sup>2</sup>	W	F	L	B	D	Paketimi	Kodi	Çmimi
●	0.5-1.5	4.0	8.5	21.5	10.5	3.8	200	GBE-1040	
●	1.5-2.5	5.0	8.5	21.3	10.5	4.7	200	GBE-2050	
●	4.0-6.0	5.0	8.5	24.0	13.0	6.2	200	GBE-5050	

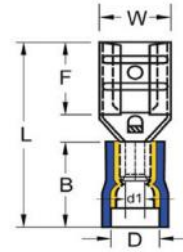
**Kapikorda femër me veshje**

Ngjyra	Seksioni mm <sup>2</sup>	Dimensioni	W	F	L	B	D	Paketimi	Kodi	Çmimi
●	0.5-1.5	0.8 X 2.8	3.2	6.5	19.0	10.5	3.8	200	GFD-1288	
●	0.5-1.5	0.8 X 4.75	5.0	6.4	19.4	10.5	3.8	200	GFD-1488	
●	0.5-1.5	0.8 X 6.35	6.6	7.5	20.8	10.5	3.8	200	GFD-1638	
●	1.5-2.5	0.8 X 2.80	3.2	6.5	19.0	10.5	4.7	200	GFD-2288	
●	1.5-2.5	0.8 X 4.75	5.0	6.4	19.4	10.5	4.7	200	GFD-2488	
●	1.5-2.5	0.8 X 6.35	6.6	7.5	20.8	10.5	4.7	200	GFD-2638	
●	4.0-6.0	0.8 X 6.35	6.6	7.5	23.3	13.0	6.2	200	GFD-5638	

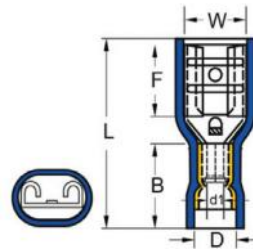
**Kapikorda femer me veshje e mbuluar**

Ngjyra	Seksioni mm <sup>2</sup>	Dimensioni	W	F	L	B	D	Paketimi	Kodi	Çmimi
●	0.5-1.5	0.8 X 2.8	3.2	6.5	19.0	10.5	3.8	200	GFFD-1288	
●	0.5-1.5	0.8 X 4.75	5.0	6.4	20.5	10.5	3.8	200	GFFD-1488	
●	0.5-1.5	0.8 X 6.35	6.6	7.5	21.8	10.5	3.8	200	GFFD-1638	
●	1.5-2.5	0.8 X 2.80	3.2	6.5	20.0	10.5	4.7	200	GFFD-2288	
●	1.5-2.5	0.8 X 4.75	5.0	6.4	20.2	10.5	4.7	200	GFFD-2488	
●	1.5-2.5	0.8 X 6.35	6.6	7.5	22.2	10.5	4.7	200	GFFD-2638	
●	4.0-6.0	0.8 X 6.35	6.6	7.5	24.2	13.0	6.2	200	GFFD-5638	

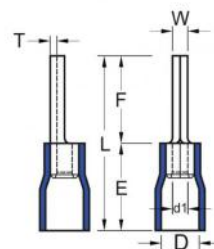
**Kapikorda gjilpërë me veshje**

Ngjyra	Seksioni mm <sup>2</sup>	W	F	L	E	U	Paketimi	Kodi	Çmimi
●	0.5-1.5	1.9	10.0	19.0	10.0	4.0	200	GIK-101	
●	1.5-2.5	1.9	12.0	21.8	10.0	4.5	200	GIK-102	
●	4.0-6.0	2.8	14.0	27.0	10.0	6.4	100	GIK-106	

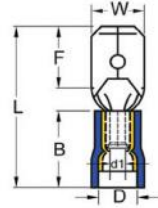
**Kapikorda mashkull me veshje**

Ngjyra	Seksioni mm <sup>2</sup>	Dimensioni	W	F	L	B	D	Paketimi	Kodi	Çmimi
●	0.5-1.5	0.8 X 2.8	2.8	6.5	19.2	10.5	3.8	200	GFE-1288	
●	0.5-1.5	0.8 X 4.75	4.8	6.7	19.8	10.5	3.8	200	GFE-1488	
●	0.5-1.5	0.8 X 6.35	6.35	7.7	21.8	10.5	3.8	200	GFE-1638	
●	1.5-2.5	0.8 X 2.80	2.8	6.7	19.8	10.5	4.7	200	GFE-2288	
●	1.5-2.5	0.8 X 4.75	4.8	6.7	19.8	10.5	4.7	200	GFE-2488	
●	1.5-2.5	0.8 X 6.35	6.35	7.7	21.8	10.5	4.7	200	GFE-2638	
●	4.0-6.0	0.8 X 6.35	6.35	7.7	24.8	13.0	6.2	200	GFE-5638	

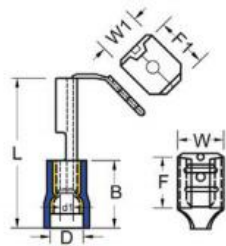
**Kapikorda mashkull- femër me veshje**

Ngjyra	Seksioni mm <sup>2</sup>	Dimensioni	W	F	L	E	D	Paketimi	Kodi	Çmimi
●	0.5-1.5	0.8 x 6.35	6.6	8.0	22.5	10.5	3.8	100	GFDEG-1861	
●	1.5-2.5	0.8 x 6.35	6.6	8.0	22.5	10.5	4.7	100	GFDEG-2862	
●	4.0-6.0	0.8 x 6.35	6.6	8.0	24.0	13.0	6.2	100	GFDEG-5866	

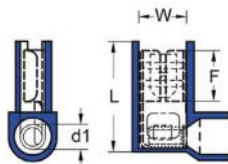
**Kapikorda femër këndore temperature**

Ngjyra	Seksioni mm <sup>2</sup>	Dimensioni	W	F	L	Paketimi	Kodi	Çmimi
●	0.5-1.5	0.8 x 6.35	6.6	7.6	16.0	100	GPFDEB-1861	
●	1.5-2.5	0.8 x 6.35	6.6	7.6	16.0	100	GPFDEB-2862	

**Kapikorda kapuç**

Ngjyra	A	B	C	D	E	Paketimi	Kodi	Çmimi
●	3.0	7.8	8.0	4.0	20.0	100	HW-C4	
●	3.8	10.5	11.0	4.5	25.3	100	HW-C5	

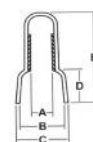

**Kapikorda terminale teke**

Ngjyra	Seksioni mm <sup>2</sup>	F	L	W	B	D	C	Kodi	Çmimi
●	0.50	8.0	14	2.6	6.0	1.3	1.0	IYA-0.50	
	0.75	8.0	14	2.8	6.3	1.5	1.2	IYA-0.75	
●	1.0	8.0	14	3.0	6.3	1.7	1.4	IYA-1.00	
●	1.5	8.0	14	3.5	6.3	2.0	1.7	IYA-1.50	
●	2.5	8.0	14	4.2	7.4	2.5	2.2	IYA-2.50	
●	4.0	10.0	17	4.8	7.4	3.2	2.8	IYA-4.00	
●	6.0	12.0	20	6.3	8.5	3.9	3.5	IYA-6.00	
●	10.0	12.0	22	7.6	8.5	4.9	4.5	IYA-10.0	
●	16.0	12.0	24	8.8	10.0	6.2	5.8	IYA-16.0	
●	25.0	16.0	28	11.2	12.0	7.7	7.3	IYA-25.0	
●	35.0	16.0	30	12.7	14.0	8.7	8.3	IYA-35.0	
●	50.0	20.0	36	15.0	16.0	10.9	10.3	IYA-50.0	

**Kapikorda terminale dyshe**

Ngjyra	Seksioni mm <sup>2</sup>	F	L	W	B	D	C	Kodi	Çmimi
●	2 X 0.50	8.0	14	5.0	6.5	1.8	1.5	CYA-0.50	
	2 X 0.75	8.0	14	5.5	6.7	2.1	1.8	CYA-0.75	
●	2 X 1.00	8.0	14	5.5	7.1	2.4	2.1	CYA-1.00	
●	2 X 1.50	8.0	14	6.4	7.5	2.6	2.3	CYA-1.50	
●	2 X 2.50	10.0	14	8.0	8.5	3.3	2.9	CYA-2.50	
●	2 X 4.00	12.0	17	8.0	11.1	4.2	3.8	CYA-4.00	
●	2 X 6.00	14.0	20	9.5	12.1	5.3	4.9	CYA-6.00	
●	2 X 10.00	14.0	27	12.6	12.6	6.9	6.5	CYA-10.00	
●	2 X 16.00	14.0	31	19.0	17.3	8.7	8.3	CYA-16.00	





Kapikorda unaze pa veshje			
Seksioni mm <sup>2</sup>	Vrima	Kodi	Çmimi
1	3	KSZ103	
	4	KSZ104	
	4	KSZ254	
2.5	5	KSZ255	
	6	KSZ256	
4.0	4	KSZ404	
	5	KSZ405	
6.0	6	KSZ406	
	6	KSZ606	
8.0	8	KSZ808	
10.0	10	KSZ1010	



Kapikorda femer pa veshje			
w	Seksioni mm <sup>2</sup>	Kodi	Çmimi
2.8	0.25-1.50	KZF028	
4.8	0.50-2.50	KZF048	
6.3	0.50-2.50	KZF063	
	2.50-4.00	KZF163	
9.5	4.00-6.00	KZF095	



Kapuç plastik për kapikorda		
w	Kodi	Çmimi
6.3 x 0.8	KFID01	



Kapikorda femer këndore			
w	Seksioni mm <sup>2</sup>	Kodi	Çmimi
6.3 X 0.8	0.50-2.50	KZK001	



Kapikorda mashkull-femër			
w	Seksioni mm <sup>2</sup>	Kodi	Çmimi
6.3 X 0.8	0.50-2.50	KZMF001	



Kapikorda femer këndore			
w	Seksioni mm <sup>2</sup>	Kodi	Çmimi
6.3 X 0.8	0.50-2.50	KMZ001	



Mashkull me stopues			
w	Seksioni mm <sup>2</sup>	Kodi	Çmimi
6.3 X 0.8	0.50-2.50	KMZS001	

Morseteri					
n°	Përmasa (mm)	Dis. Vrimave (mm)	Bulloni	Kodi	Çmimi
1	40x25	15	Ø 4	MS14025	
2	50x30	20	Ø 4	MS25030	
3	60x37	25	Ø 5	MS36037	
4	73x44	30	Ø 6	MS47344	
5	91x56	35	Ø 8	MS59156	
6	115x70	45	Ø 10	MS611570	
7	150x95	55	Ø 12	MS715095	





**Për kapikorda te veshura 0.50-6.00mm<sup>2</sup>**

 Kodi **YYT7**  
 Çmim

**Për kapikorda pa veshje 0.50-6.00mm<sup>2</sup>**

 Kodi **YYT11**  
 Çmim

**Për kapikorda pa veshje 0.5-6.00mm<sup>2</sup>**

 Kodi **YAC6**  
 Çmim

**Për kapikorda tubolare 0.08-6.00mm<sup>2</sup>**

 Kodi **YAC9**  
 Çmim

**Për kapikorda tubolare 0.08-6.00mm<sup>2</sup>**

 Kodi **YAC8**  
 Çmim

**Pinca Multifunkionale për kapikorda**

 Kodi **YYTB4**  
 Çmim

**Për kapikorda industriale 5.00-50.00mm<sup>2</sup>**

 Kodi **JY0650**  
 Çmim

**Për kapikorda industriale 16.00-300.00mm<sup>2</sup>**

 Kodi **YQK300**  
 Çmim

**Pinca per prerje kabelli deri 325 mm<sup>2</sup>**

 Kodi **TCR- 325**  
 Çmim